

# ROLOK PRODUCTS *"Proud Of Our Work!"*



**Your Complete Source for  
HVAC Duct Work,  
Fittings, & Supplies**



4800 North Channel Avenue, Portland, OR 97217  
Phone: (877) 826-3828 Fax: (503) 285-1327

## **QUALITY**

Our quality begins with the use of only the finest-quality materials. The extensive use of computer-controlled machinery allows ROLOK to maintain its trademark fit, finish and repeatability between product runs. Our skilled craftsmen maintain the industry's highest level of quality and assure that the product you receive is the best available.

## **RELIABILITY**

We understand that your work is deadline driven, so we specialize in delivering your order complete and on time. Your order can be delivered as a complete package or phased onto the job as needed.

## **FLEXIBILITY**

Every ROLOK order is a custom job, built to your specifications and time schedule. This assures that the materials used and construction methods employed are a perfect match for your application. With ROLOK you never have to "make do" with marginal materials, even in the most demanding situations.

## **VERSATILITY**

ROLOK can provide you with a full range of sheet metal products from HVAC and cleanroom ductwork to blow pipe and heavy gauge grease duct. Galvanized steel, black iron, aluminum and all grades of stainless steel can be fabricated in thicknesses from 26 gauge to 3/16 inch. Internally insulated duct and ductboard fabrication is also available.

## **SERVICE**

ROLOK Products is based on a 40-year tradition of customer service and responsiveness to our customers' needs. Our staff of talented, personable people understand the HVAC industry and are dedicated to providing premium-quality products at a reasonable cost. ROLOK specializes in production for jobs on tight schedules and meets those schedules at no extra charge in all but the most extreme cases.

## **DELIVERY**

ROLOK Products will deliver your order to the jobsite or other location as required. Duct can be delivered fully assembled or knocked down for field assembly. All materials required for field assembly of knocked down duct are available. Jobsite technical assistance can be provided upon request.

## **CONFIGURATIONS**

- Spiral Pipe: Available in Diameters from 3 in. through 60 in., with thicknesses from 26 through 16 gauge.
- Rolled Pipe & Fittings through 3/16 in. thickness
- Regular - TDC, S&Drive, Ductmate
- All configurations are available either insulated or uninsulated

## **MATERIALS**

- Galvanized Steel
- Stainless Steel - all alloys
- Aluminum
- Black Iron
- Ductboard

## **ACCESSORIES FROM LEADING MANUFACTURES**

- Shoemaker
- Duro Dyne
- Thermafex
- Stamped Fittings
- Metalbestos



**ROLOK supplies everything from individual parts and accessories to a complete system.**

## **SAVING TIME SAVES MONEY**

Key to a successful duct order is organizing the material for delivery to the jobsite. Careful attention to detail during the ordering process can enhance profitability on a project. The following guidelines are provided as ways to save many hours of wasted field labor.

## **CLEARLY LABEL EACH PIECE OF DUCT FOR THE SYSTEM INTO WHICH IT FITS**

Provide fitting numbers for each piece of the system if this is appropriate. This information will be printed on the labels that ROLOK applies to each piece of duct.

## **SPECIFY DIFFERENT LABEL COLORS FOR THE DIFFERENT SYSTEMS OR SECTIONS OF THE JOB**

This allows you to sort the material by color when it arrives on the job greatly speeding up receiving and making it faster to distribute the material within the building. ROLOK uses seven label colors: blue, green, orange, pink, purple, white and yellow.

## **ORDER YOUR JOB IN SMALLER SECTIONS**

Ordering material by floor, wing or other reasonable section of the job will prevent overloading of the job site with excessive amounts of material. This reduces sorting time and eliminates the need to move material multiple times as the job progresses. ROLOK's "just in time" deliveries ensure that material is available for your field crews as the job progresses. Ordering jobs in this fashion will not add to the cost of the job if the material is ordered in full truckloads.

## **CONSIDER USING A SINGLE GAUGE STANDARD FOR ALL SPIRAL DUCT ON THE JOB**

For a minimal increase in price, a single gauge standard allows your field personnel to use any piece of spiral anywhere in the system. This eliminates time-consuming sorting by gauge and eliminates the even more costly chance of installing material inappropriate for the application.

## **ORDER FULL-LENGTH PIECES OF STRAIGHT DUCT**

Ordering your rectangular duct in 59 in. lengths for S&Drive and 56 in. lengths for TDC duct will cost the same or less than shorter lengths. This applies to both sound attenuated and uninsulated duct.

## Convenient Ordering

ROLOK is capable of building from any cut sheet, line drawing, or any sketch that you provide. For your added convenience, ROLOK has created an easy to use “letter system” order form as a way of guaranteeing that the product you receive is the product you specified.

Completed order forms may be faxed to (503) 285-1327.

## How to Order ROLOK Duct and Fittings

**1.** Complete the top portion of the order form with the following information Job No., Job Name, Ordered By (your name); Date Ordered; Date Required; Sheet No.; Tag Color; System WG; and Material (GI - galvanized; SS - stainless steel; AL - aluminum; BLK - black iron).

If you have questions regarding the system water gauge, please give us a call.

**2.** From our catalog determine the fittings needed and list the appropriate item number under ITEM # and the quantity needed under QTY.

**3.** Under each letter (A, B, C, etc.) list the dimensions required for each fitting, following the fitting diagram.

**4.** Indicate the CONNECTION required using the following abbreviations: S/D (for S&Drive); TDC; or LF (for loose flange). For no connection, write the word RAW.

**5.** If the duct is to be lined for sounds attenuation, under LINER note 1in. or 2 in., depending on requirements. If no liner is needed, leave blank.

**6.** Indicate the FITTING NO (number) of each piece if appropriate. This information will be printed on the labels that ROLOK applies to each piece of duct.

**F1 Example**

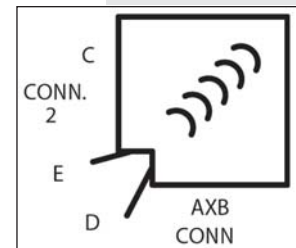

ITEM (Shop Use Only)	ITEM#	QTY.	A	B	C	D	E	F	G	H	CONNECTION			LINER	FITTING NO. REMARKS
											1	2	3		
	F1	1	12	6	6	12	10				S/D	S/D		1"	G1

# Rectangular Duct

**All products manufactured to specifications in  
ROLOK's on-site facility.**

90° Square Elbow.....	6
90° Square Throat Radius Elbow.....	6
45° Radius Elbow.....	6
90° Radius Elbow.....	7
45° Square Elbow.....	7
Square Tee.....	7
Transition on Center.....	8
Rectangular Transitions Flat on One Side.....	8
Transition Twister.....	8
Square to Round.....	9
Rectangular Ogee Offset.....	9
Transitional Rectangular Ogee Offset.....	9
Offset Transition.....	10
Rectangular Offset.....	10
Rectangular End Cap.....	10
Rectangular 45° Tap-In.....	11
Square Tap-In.....	11
TDC and Sound Attenuating.....	12
Miscellaneous.....	13

**ROLOK** PRODUCTS

Quality Sheet Metal Fabrication

## F1 - 90° Square Elbow

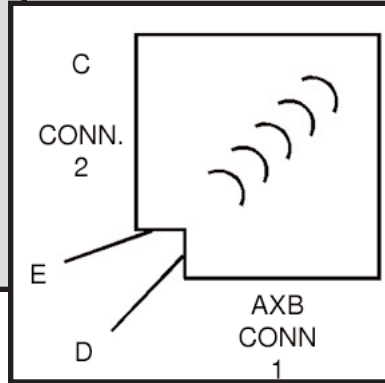

## F2 - 90° Square Throat Radius Elbow

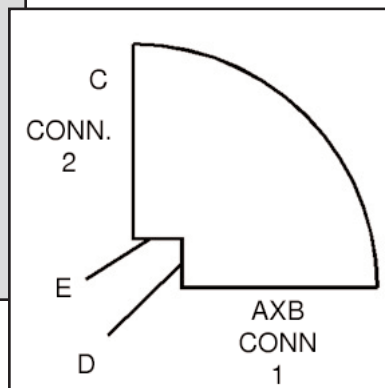

## F3 - 45° Radius Elbow

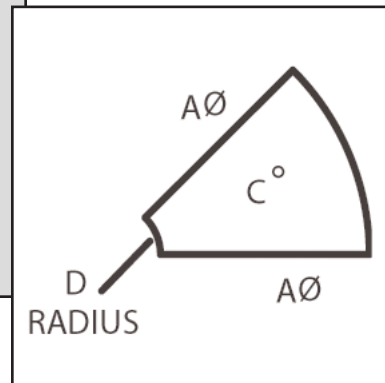
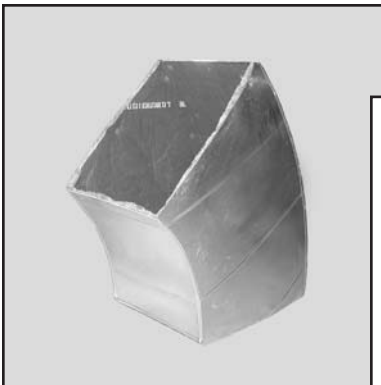

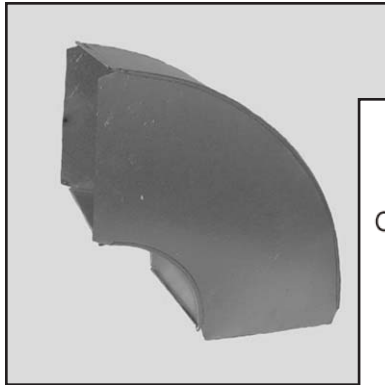

### F4 - 90° Radius Elbow

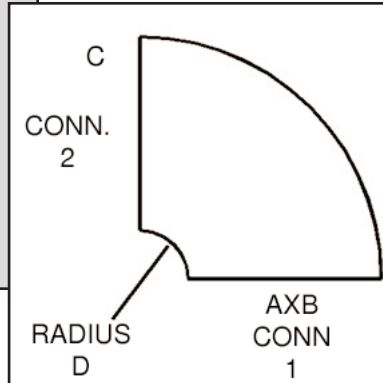

### F5 - 45° Square Elbow

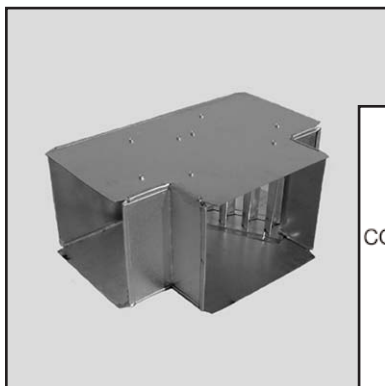
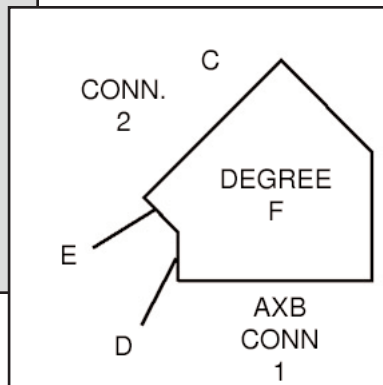

### F6 - Square Tee

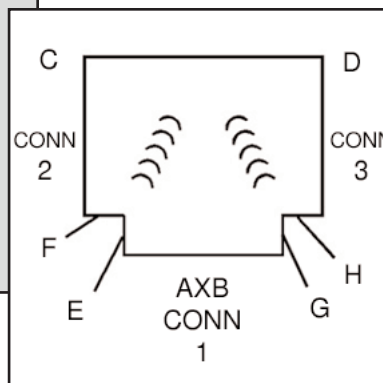



## F7- Transition on Center

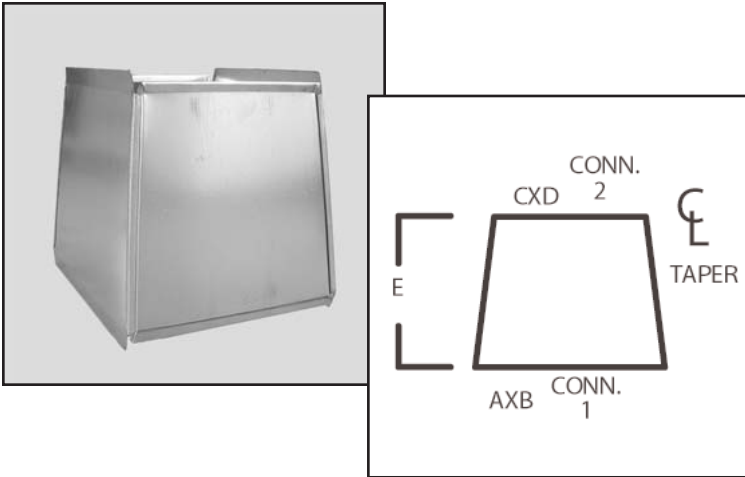

## F8 - Rectangular Transitions Flat on One Side

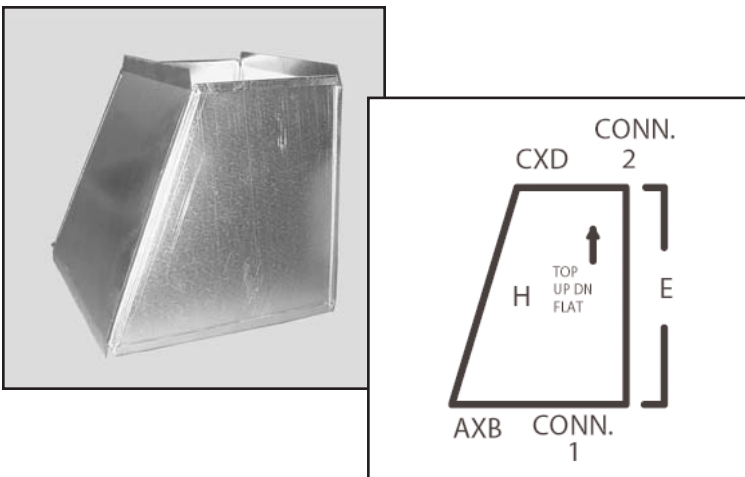

## F9 - Transition Twister

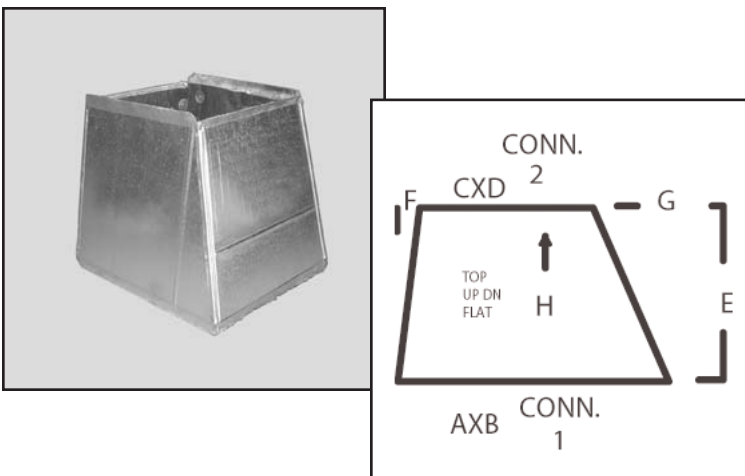



### F10 - Square to Round

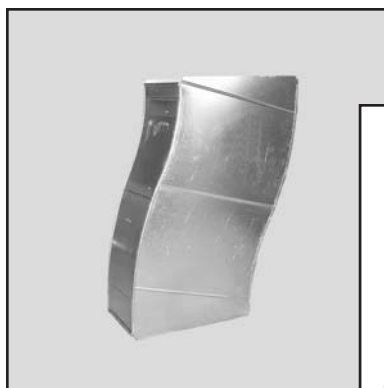
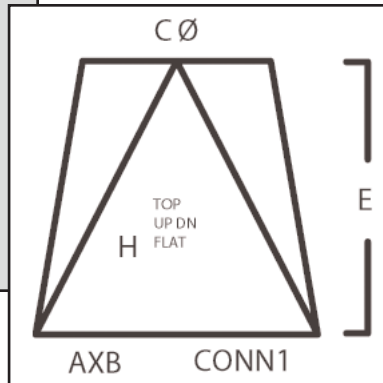

### F11 - Rectangular Ogee Offset

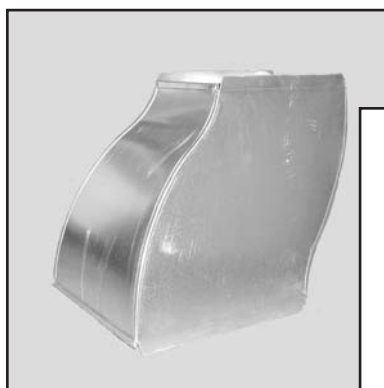
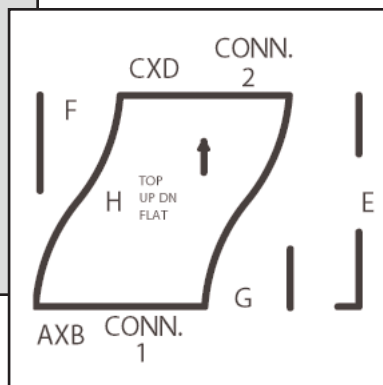

### F12 - Transitional Rectangular Ogee Offset

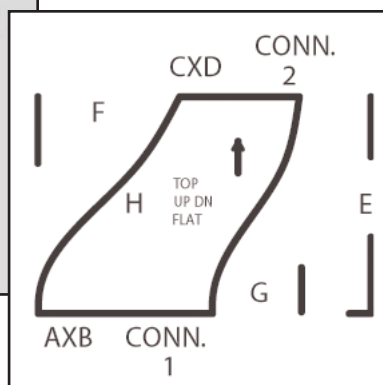

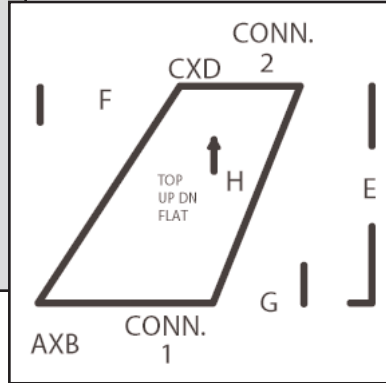

**F13 - Offset Transition**

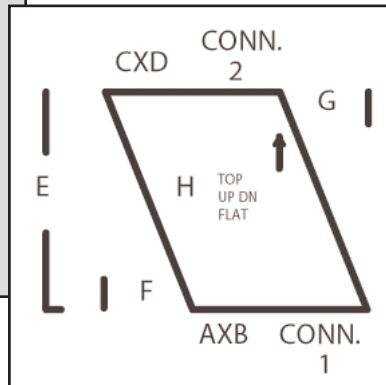
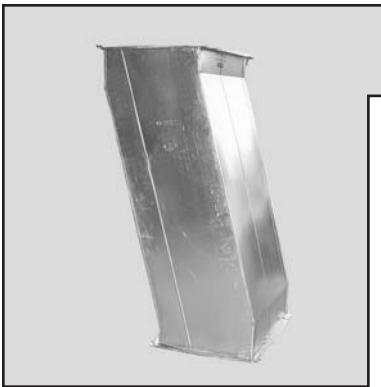

**F14 - Rectangular Offset**

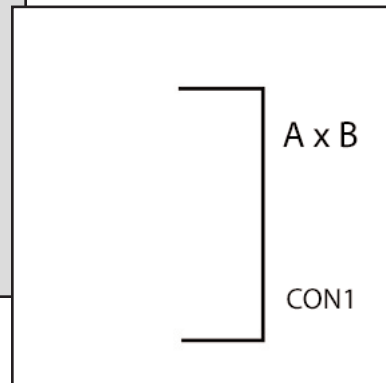

**F15 - Rectangular End Cap**

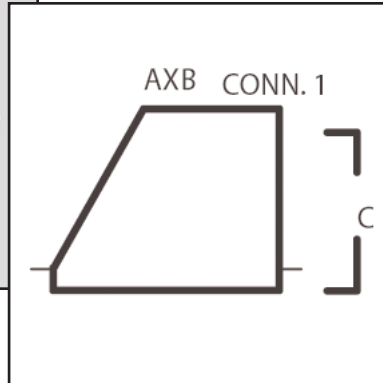
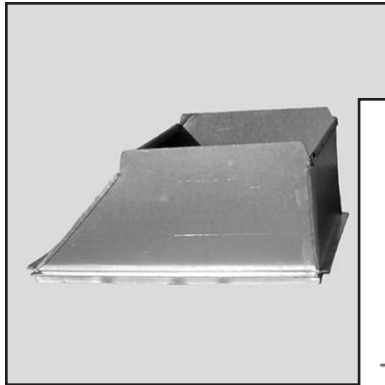

**F16 - Rectangular 45° Tap-In**

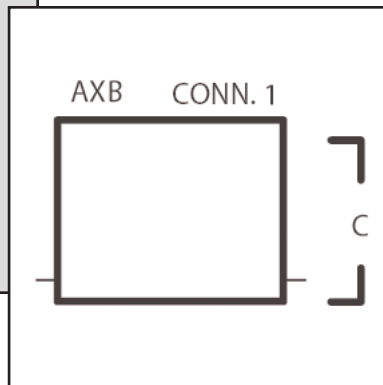
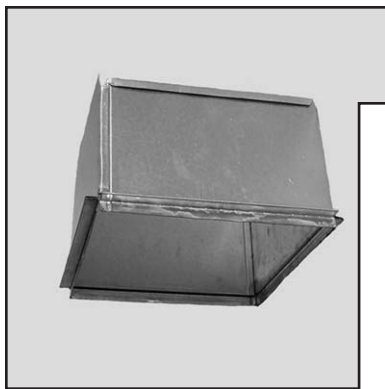

**F17 - Square Tap-In**

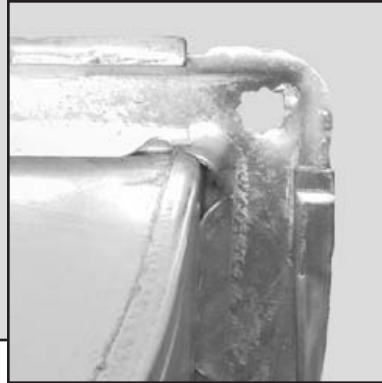
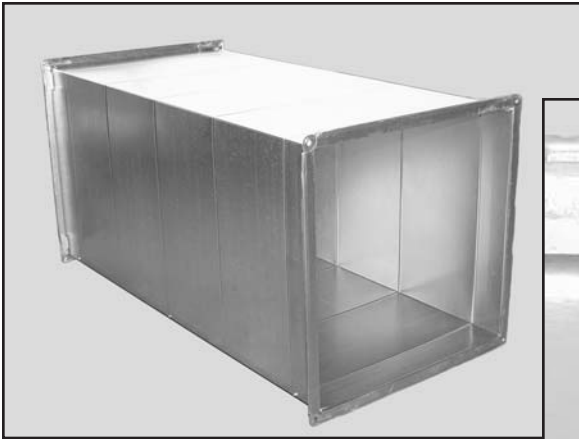

## **TDC Duct**

Coil Line Duct  
56" Lengths  
Most Economical  
Rectangular Duct



## **Rectangular Duct with Sound Attenuating Liner**

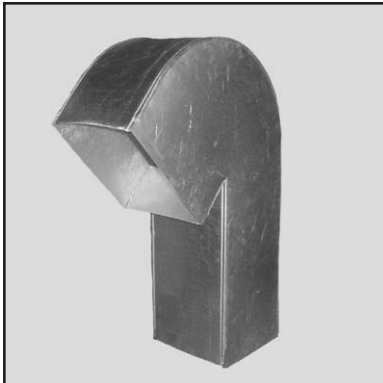

**Rectangular  
Gooseneck**



**Rectangular Grease  
Duct**

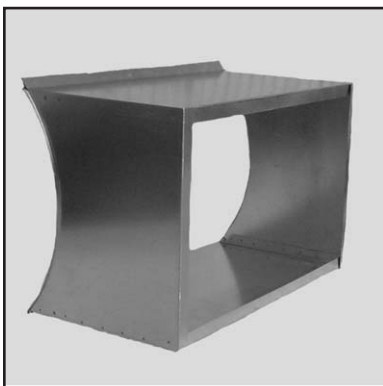

**Rectangular on Round  
Diffuser Takeoff**

# Round Duct

**All products manufactured to specifications in ROLOK's on-site facility with the exception of Stamped Fittings, Inc. products.**

Round 90° Elbow.....	16
Round 45° Elbow.....	16
Die Stamped 1-piece Flangless Elbows (Stamped Fittings, Inc.)	17
Round Taper.....	18
Round Offset.....	18
Round Taper Flat on One Side.....	18
Round Reducing Offset.....	19
Wye.....	19
45° Lateral Taper Tee.....	20
Tees.....	20
Round from Flat Tap.....	21
Round Conical Tap from Flat.....	21
Round from Round Tap.....	21
Conical Tap.....	22
Round from Round 45° Tap.....	22
Round End Cap.....	22
Round Gooseneck.....	23
Round to Oval.....	23
Crimped Duct End.....	24
Round Duct Bell & Spigot.....	24

**ROLOK** PRODUCTS

Quality

Sheet Metal Fabrication

## R1 - Round 90° Elbow

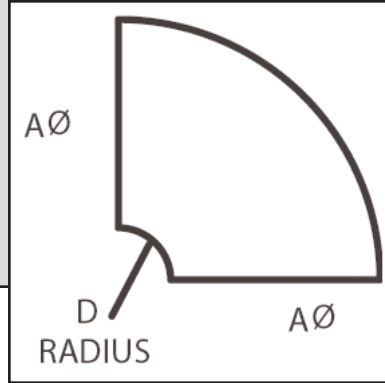

---

## R2 - Round 45° Elbow

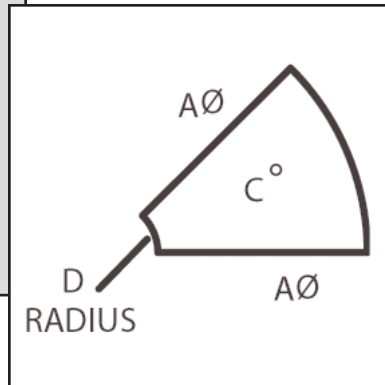



# Round Duct

---

**ROLOK** PRODUCTS



**SFDS1E - 90° Die  
Stamped 1-piece  
flangless elbow**



**SFDS1E - 45° Die  
Stamped 1-piece  
flangless elbow**



## R3 - Round Taper

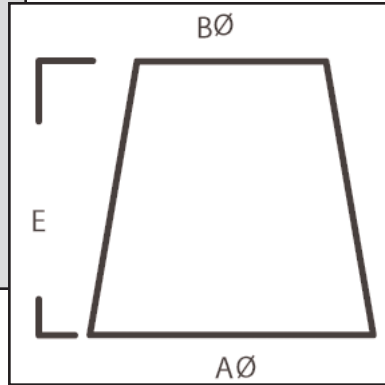

## R4 - Round Offset

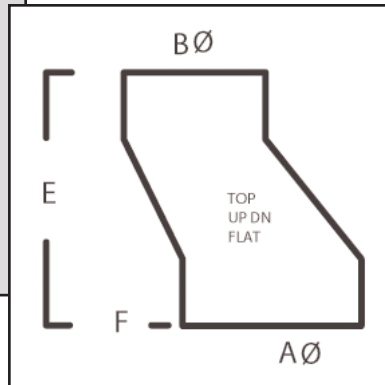

## R5 - Round Taper Flat on One Side

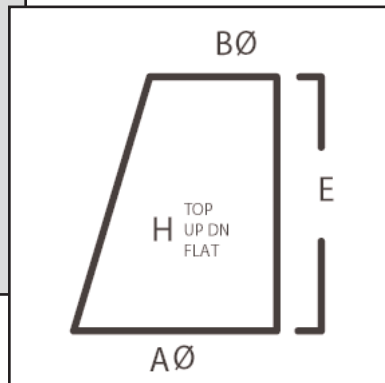

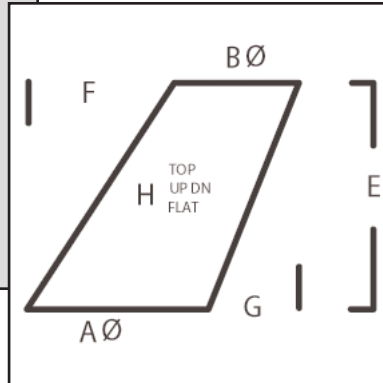

**R6 - Round Reducing Offset**

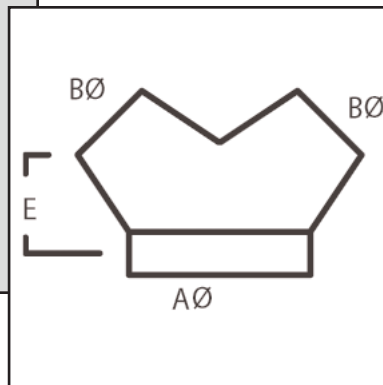

**R7 - Wye**



**R7A - Wye**

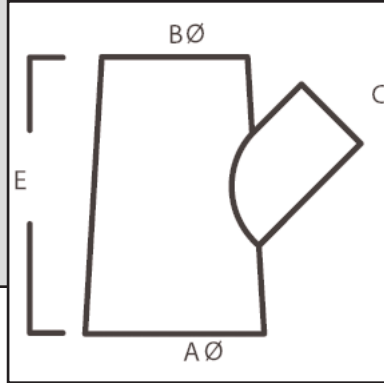

**R8 - 45° Lateral Taper Tee**

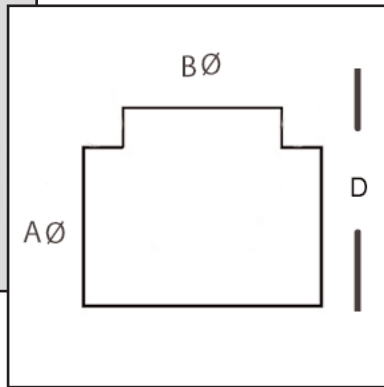
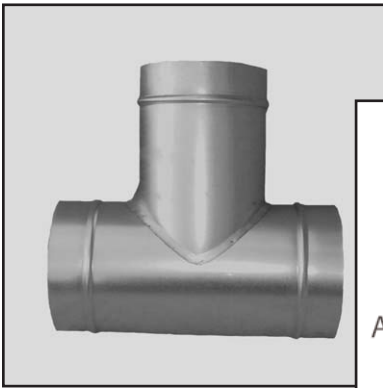

**R8A - Tee**

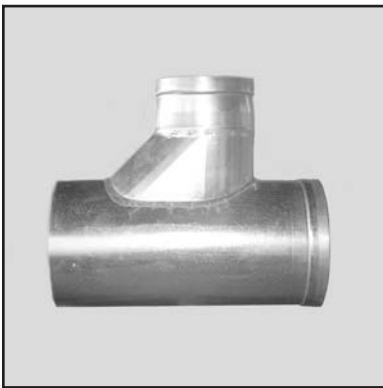

**R8B - Tee**

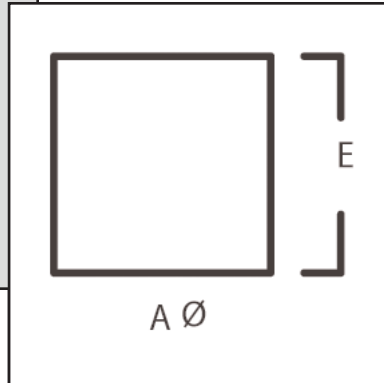

**R9 - Round from Flat Tap**

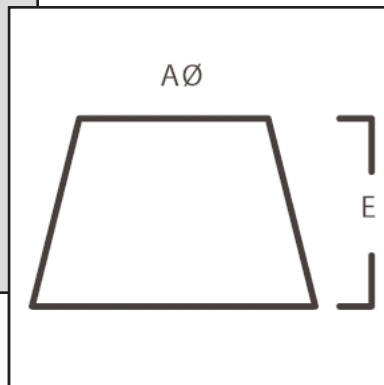

**R10 - Round Conical Tap from Flat**

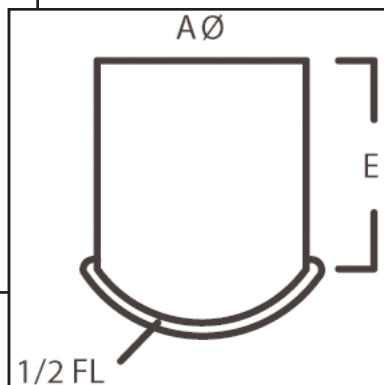
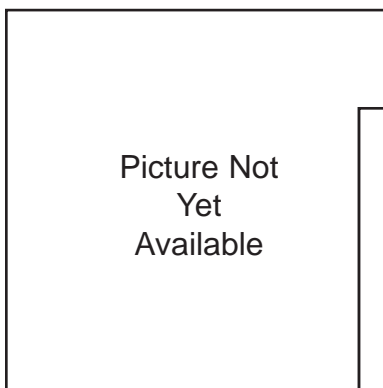

**R11 - Round from Round Tap**

## R12 - Conical Tap

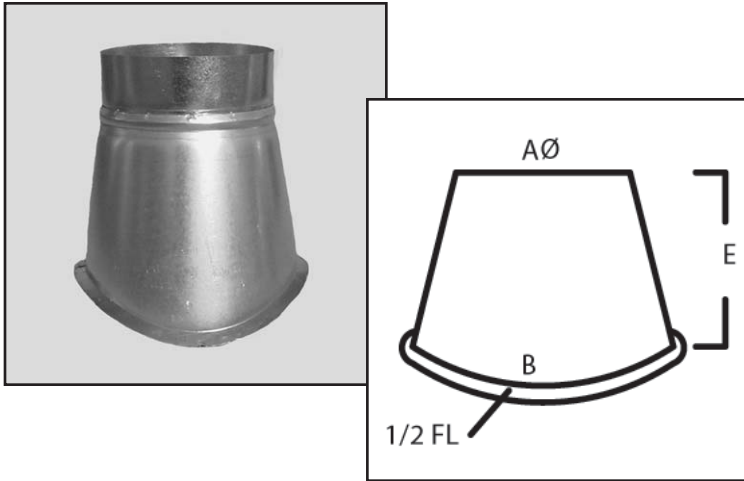

---

## R13 - Round from Round 45° Tap

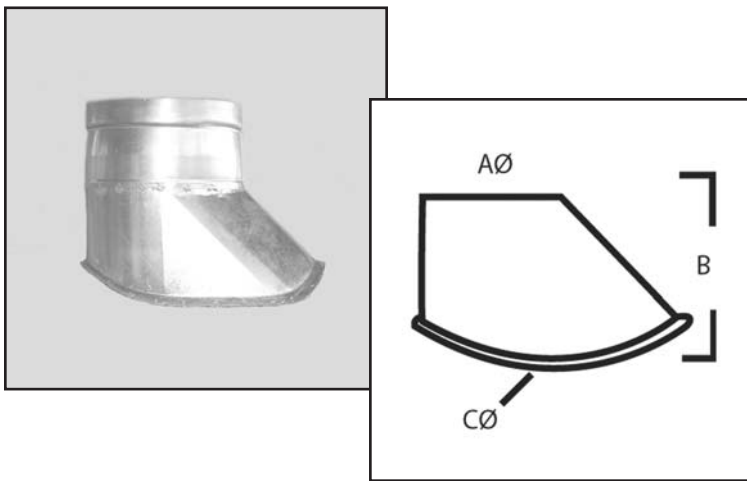

---

## R20 - Round End Cap

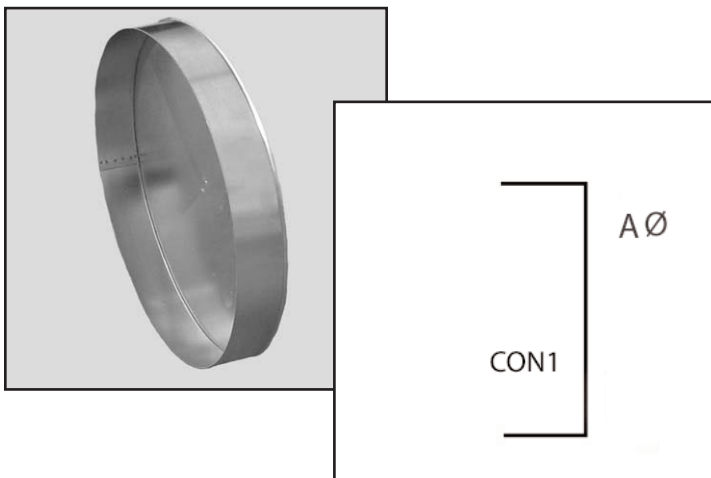

# Round Duct

---



**Round Gooseneck**



**Round to Oval**

## **Crimped Duct End**

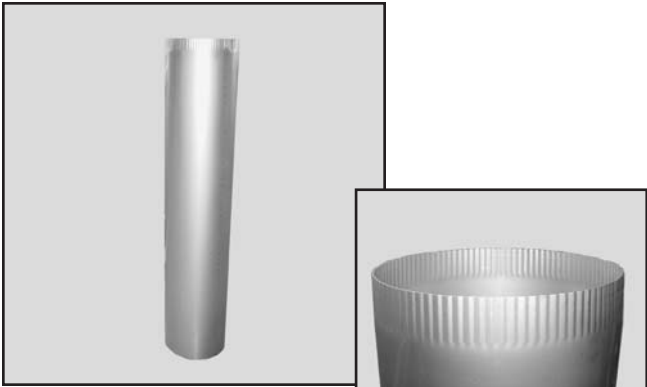

---

## **Round Duct Bell & Spigot**

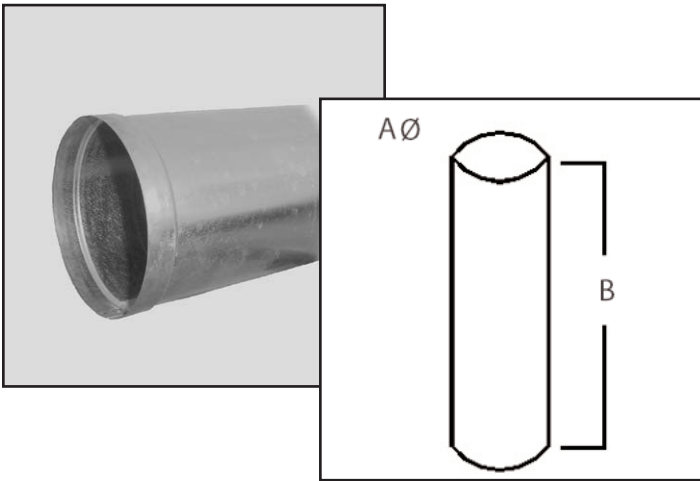



# Spiral Duct

**All products manufactured to specifications in  
ROLOK's on-site facility.**

Available Sizes..... 26

**ROLOK** PRODUCTS

Quality Sheet Metal Fabrication



**Available in the following diameter sizes:**

**4", 6", 7", 8", 9", 10", 11",  
12", 14", 15", 16", 18", 20",  
21", 22", 24", 26", 28", 30",  
32", 34", 36", 38", 40", 42",  
44", 46", 48", 52", 54", 56",  
58", 60"**

**Minimum Length 5'**

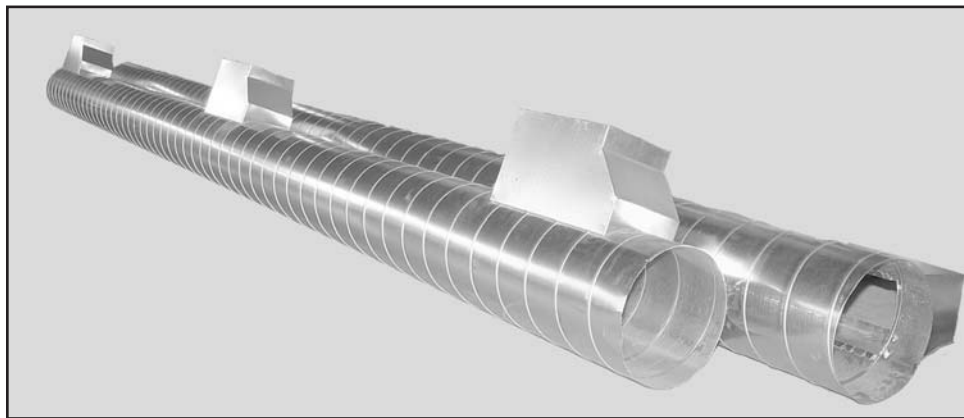

# Duct Connectors & Miscellaneous Duct

**All products manufactured to specifications in  
ROLOK's on-site facility with the exception of  
Ductmate Industries, Inc. and Stamped  
Fittings, Inc. products.**

Flat Drive .....	28
Standing Drive .....	28
S Drive .....	28
Standing S Drive .....	29
Ductmate .....	29
Ductmate Industries, Inc. Products .....	30
Flange .....	31
Round Connector .....	32
Take Offs .....	32
Caps .....	33
Collars .....	33
Bird Screens .....	33
Hanger Strap .....	34
Turning Vane .....	34

**ROLOK** PRODUCTS

Quality Sheet Metal Fabrication

**Cleats & Ductmate**

Flat Drive

**ROLOK** PRODUCTS



Standing Drive

**ROLOK** PRODUCTS

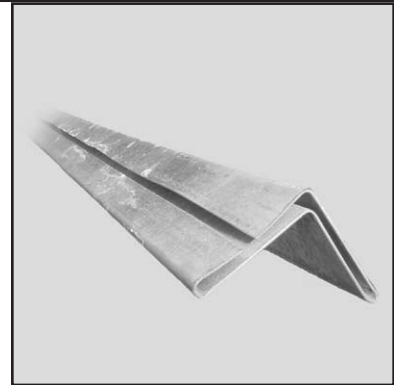

S Drive

**ROLOK** PRODUCTS

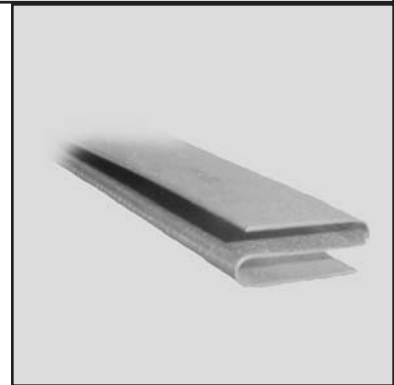

**Cleats & Ductmate**

Standing S Drive

**ROLOK** PRODUCTS

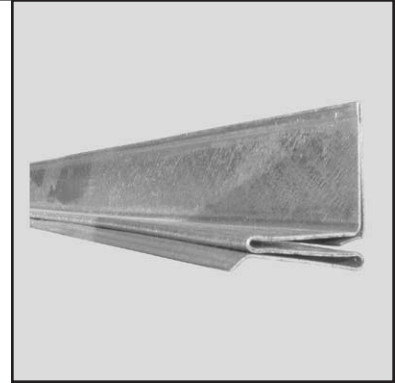

Ductmate

**ROLOK** PRODUCTS



**Ductmate Products****Ductmate “Large Flange” Series**

<b>D-LFN</b>	Nuts - 100 pcs/box
<b>D-LF20</b>	Flange - 20' Lengths per ft.
<b>D-LFB</b>	Bolts - 100 pcs/box
<b>D-LFC</b>	Corners - 250 pcs/box
<b>D-LFCC</b>	Corners w/clips 250 pcs/box

**Ductmate “Small Flange” Series**

<b>D-SFN</b>	Nuts - 100 pcs/box
<b>D-SF20</b>	Flange - 20' Lengths per ft.
<b>D-SFB</b>	Bolts - 100 pcs/box
<b>D-SFCC</b>	Corners w/ clips - 250 pcs/box

**Ductmate Accessories**

<b>D-DAGC10</b>	10' Galv Cleat - 250 ctn per piece
<b>D-DAGC6</b>	6" Galv Cleat - 500 ctn per piece
<b>D-DAPC6</b>	6" PVC Cleat - 500 ctn per piece
<b>D-DATC6</b>	6" TDC Cleat - 500 ctn per piece
<b>D-DA400B</b>	400 Butyl Gasket - 25' per roll
<b>D-DAC</b>	Corner - 250 ctn per piece
<b>D-DACT</b>	Cleater Tool
<b>D-DAC25</b>	Clips 25/35 - 500 pcs/ctn per piece
<b>D-DACS</b>	Corner - 250 ctn per piece, Stackable
<b>D-DABS</b>	Bracket Strap, Galv.
<b>D-DANG</b>	Neoprene Gasket - 50' Roll
<b>D-DAER</b>	Easy Rods 1/2" Box - 250 pcs ctn
<b>D-DAGC20</b>	20' Galv. Cleat - ea.

## Flange

### Round Flange

**ROLOK** PRODUCTS

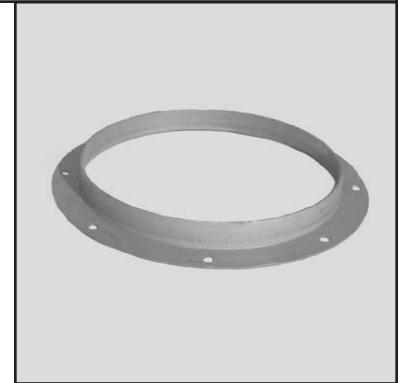
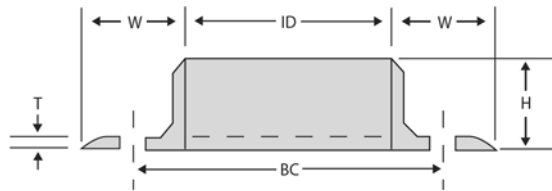

### Vanstone Flange

**ROLOK** PRODUCTS

\* Available on ROLOK All Round Fittings & ROLOK Non-Spiral Pipe

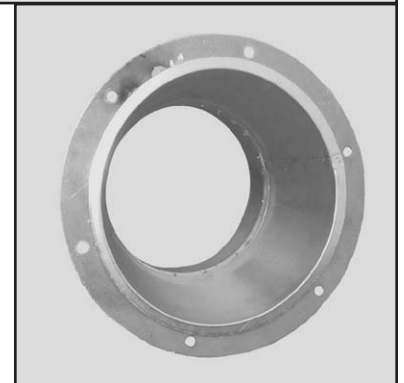

### Duraflange

\* Available in sizes 18" - 102".

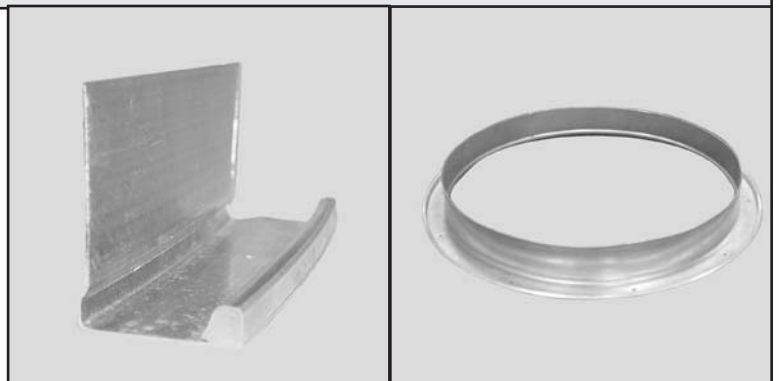

### Connectors

Round Connector

ROLOK PRODUCTS



### Take Offs

Spin In Take-Offs for Sheet Metal - With or Without Damper

ROLOK PRODUCTS



Spin In Take-Offs for Sheet Metal - With or Without Damper





**Caps**

Rain Caps

**ROLOK** PRODUCTS



**Collars**

Collars

**ROLOK** PRODUCTS



**Bird Screen**

Bird Screen

**ROLOK** PRODUCTS

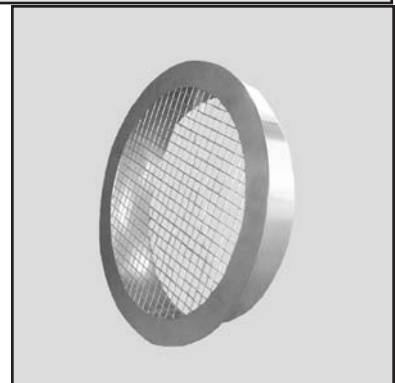

## Turning Vane

### Turning Vane & Rail

Turning Vane - 10', 26 Ga. w/2" radius

Vane Rail - 10', 22 Ga.

Acoustic Vane Rail 4" x 10"

Acoustic Turn Vane 4" x 10"

## Hanger Strap

### 1" Hanger Strap 26 GA.

**ROLOK** PRODUCTS





**Stamped  
Fittings, Inc.**

# Products

Die Stamped 1-piece Flangeless Elbow.....	SF-2
Die Stamped Bellmouth Take-Off.....	SF-3
High Efficiency Take-Off.....	SF-4
Die Stamped 90° Saddle Tap.....	SF-5
Fabricated 45° Saddle Tap.....	SF-6
One Piece Spun Reducer.....	SF-7
Spun End Cap.....	SF-7

### Elbows

#### Die Stamped 1-Piece Flangeless Elbow

Prod# SF-DS1E

Materials Avail.

Galvanized G90  
(5" to 7") 24 Gauge

Galvanized G90  
(8" to 12") 22 Gauge

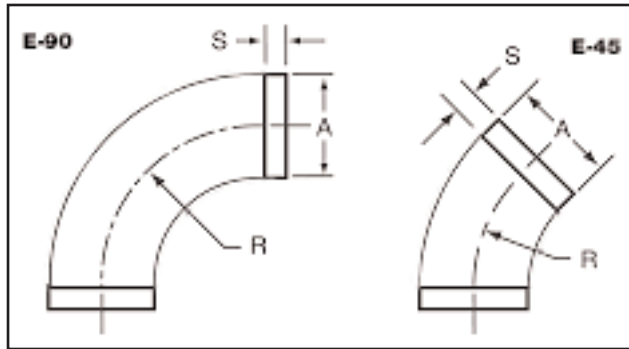

Nominal Size	Diameter (A)	E-45 (R)	Wt. 45's	E-90(R)	Wt. 90's
5"	4 <sup>7</sup> / <sub>8</sub> "	7.5	1.3	7.5	2.3
6"	5 <sup>7</sup> / <sub>8</sub> "	9.0	1.5	9.0	2.2
7"	6 <sup>7</sup> / <sub>8</sub> "	10.5	2.4	10.5	4.2
8"	7 <sup>7</sup> / <sub>8</sub> "	12.0	3.0	12.0	4.7
9"	8 <sup>7</sup> / <sub>8</sub> "	13.5	3.8	13.5	7.0
10"	9 <sup>7</sup> / <sub>8</sub> "	15.0	4.2	15.0	7.6
12"	11 <sup>7</sup> / <sub>8</sub> "	18.0	6.5	18.0	10.2



**Stamped  
Fittings, Inc.**

**Take-Offs**

**Die Stamped Bellmouth Take-Off**

Prod# SF-DSBTO

Materials Avail.

Galvanized G90  
24 Gauge

Available with or  
without Damper

Also available with or  
without a peel & stick  
gasket on flange

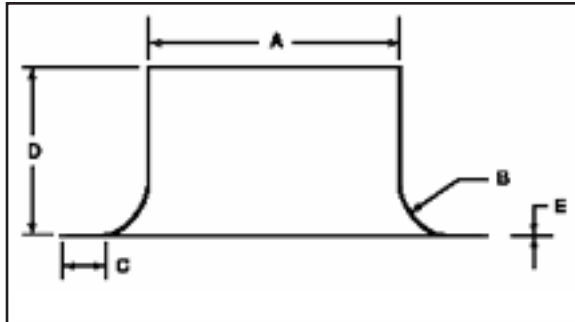

Pipe Size (A)	Radius (B)	Flange Lgth. (C)	Height (D)	Thickness (E)	Weight
5 15/16"	1.0"	1"	4.3"	.027	0.75
5 15/16"	1.0"	1"	4.3"	.027	1.10
7 15/16"	1.0"	1"	4.3"	.027	1.15
7 15/16"	1.0"	1"	4.3"	.027	1.59
9 15/16"	1.0"	1"	4.3"	.027	1.50
9 15/16"	1.0"	1"	4.3"	.027	2.03
11 15/16"	1.0"	1"	4.3"	.027	2.00
11 15/16"	1.0"	1"	4.3"	.027	2.75



### Take-Offs

#### High Efficiency Takeoff

Prod# SFHETO

Materials Avail.

Galvanized  
26 Gauge

Available with or  
without Damper

Also available with or  
without a peel & stick  
gasket on flange

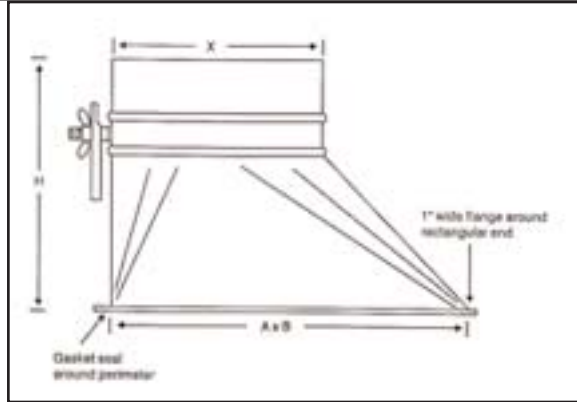

Diameter (X)	Base (A x B)	Height (H)
5"	10" x 5"	9.5"
6"	12" x 6"	9.5"
7"	12" x 6"	9.5"
8"	12" x 6"	9.5"
9"	15" x 6"	10.5"
10"	16" x 6.75"	10.5"
12"	18" x 8.5"	10.5"
14"	20" x 9.5"	10.5"
16"	24" x 12"	10.5"



## Saddle Taps

### Die Stamped 90° Saddle Tap

Prod# SFDS90ST

Materials Avail.

Galvanized G90  
24 Gauge (.035)

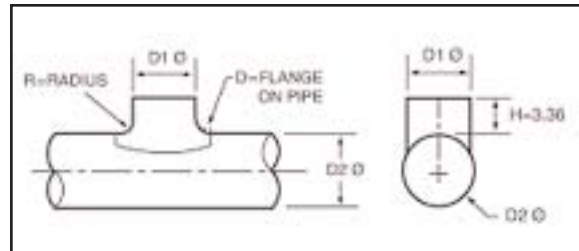

Branch Size (D1)	Pipe Size (D2)	Gauge	Weight	Radius (R)	Flange (B)	Height (H)
6"	8"	0.027"	0.8	0.787"	1.0"	3.36"
6"	10" - 12"	0.027"	0.7	0.787"	1.0"	3.36"
6"	14" - 18"	0.027"	0.7	0.787"	1.0"	3.36"
6"	20" - 24"	0.027"	0.6	0.787"	1.0"	3.36"
8"	10"	0.027"	1.3	1.0"	1.0"	3.36"
8"	12" - 14"	0.027"	1.1	1.0"	1.0"	3.36"
8"	16" - 18"	0.027"	1.1	1.0"	1.0"	3.36"
8"	20" - 24"	0.027"	1.0	1.0"	1.0"	3.36"
10"	12"	0.027"	2.0	1.0"	2.0"	3.36"
10"	14" - 16"	0.027"	1.8	1.0"	2.0"	3.36"
10"	18" - 20"	0.027"	1.8	1.0"	2.0"	3.36"
10"	22" - 24"	0.027"	1.7	1.0"	2.0"	3.36"
12"	14" - 16"	0.027"	2.0	1.0"	2.0"	3.36"
12"	18" - 20"	0.027"	2.3	1.0"	2.0"	3.36"
12"	22" - 24"	0.027"	2.1	1.0"	2.0"	3.36"



**Saddle Taps**

Fabricated 45° Saddle Tap

Prod# SF-F45ST

Materials Avail.

Galvanized G90  
24 Gauge (.035)SE x +/- 1/2" flange  
out

<b>Diameter (A)</b>	<b>Diameter (B)</b>	<b>Weight</b>
6"	On any pipe size	1.41
8"	On any pipe size	1.87
10"	On any pipe size	2.34
12"	On any pipe size	2.81
14"	On any pipe size	4.32
16"	On any pipe size	4.93
18"	On any pipe size	5.55
20"	On any pipe size	6.16
22"	On any pipe size	6.78
24"	On any pipe size	7.40





## Reducer

### One Piece Spun Reducer Prod# SF-OPSR

Materials Avail.

Galvanized G90  
20 or 22 Gauge

Sizes 4" up to 24"

Small ends fit into spiral pipe

Other sizes and materials available upon request

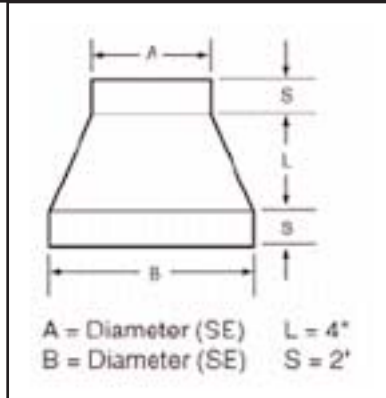

## Caps

### Spun End Cap Prod# SF-SEC

Materials Avail.

Galvanized 24 Gauge

Sizes 3" up to 30"

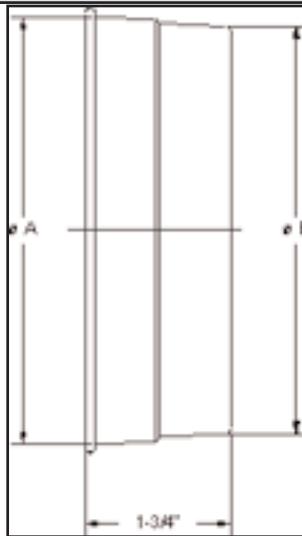

A = Large End to fit over Sprial Pipe, + 1/8" (Cap)

B = Small End to fit in Sprial Pipe, - 1/8" (Plug)



# Miscellaneous Sheet Metal & Sheet Metal Products

Dampers.....	A2
Furnace Accessories.....	A3 - A9
Oval Products .....	A10 - A11
Round Pipe & Fittings.....	A12 - A13
Adjustable Elbows .....	A14 - A15
Register, Specialty, & Miscellaneous Boots.....	A16 - A21
Take-Offs.....	A22
Wall Stack.....	A22 - A24
Duct Hanging Accessories.....	A25 - A29
Access Doors.....	A29 - A30
Fire Dampers.....	A31 - A33



### Dampers

#### Volume Damper

**ROLOK** PRODUCTS

**A-VD**

Rectangular or Round

$\frac{3}{8}$ " rod w/ KR3 Handle & SB138 Bearing Set

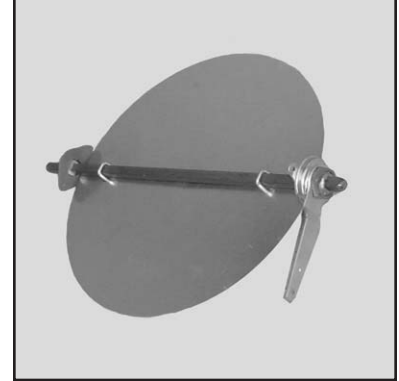

#### Jiffy Dampers

**DURO  
DYNE**

**A-JD**

Dampers

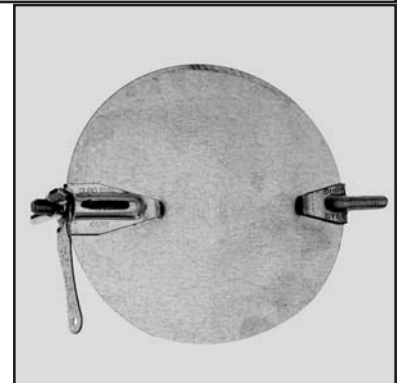

**Furnace Accessories****Columbia Base Cans - Air Handler 18" Tall**

<b>A-BC18I</b>	18 1/2" x 20 1/2" Insulated
<b>A-BC21I</b>	21 1/2" x 21" x 18" Insulated
<b>A-BC23I</b>	23 1/2" x 21" x 18" Insulated
<b>A-BC26I</b>	26" x 21" x 18" Insulated
<b>A-BC18</b>	18 1/2" x 20 1/2"
<b>A-BC21</b>	21 1/2" x 21"
<b>A-BC23</b>	23 1/2" x 21"
<b>A-BC26</b>	26" x 21"

**Columbia Base Cans Furnace with End Cap 18" Tall, 24 Gauge**

<b>A-F1814I</b>	14 5/8" x 28 1/4" Insulated
<b>A-F1817I</b>	17 3/4" x 28 1/4" Insulated
<b>A-F1821I</b>	21 1/4" x 28 1/4" Insulated
<b>A-F1824I</b>	24 3/4" x 28 1/4" Insulated
<b>A-F1814</b>	14 5/8" x 28 1/4"
<b>A-F1817</b>	17 3/4" x 28 1/4"
<b>A-F1821</b>	21 1/4" x 28 1/4"
<b>A-F1824</b>	24 3/4" x 28 1/4"

**Furnace Accessories****Columbia Base Cans Furnace with End Cap 24" Tall, 24 Gauge****A-F2414I** 14 5/8" x 28 1/4" Insulated**A-F2417I** 17 3/4" x 28 1/4" Insulated**A-F2421I** 21 1/4" x 28 1/4" Insulated**A-F2424I** 24 3/4" x 28 1/4" Insulated**A-F2414** 14 5/8" x 28 1/4"**A-F2417** 17 3/4" x 28 1/4"**A-F2421** 21 1/4" x 28 1/4"**A-F2424** 24 3/4" x 28 1/4"**Columbia Base Cans Furnace with End Cap 36" Tall, 24 Gauge****A-F3614I** 14 5/8" x 21" Insulated**A-F36148I** 14 5/8" x 28 1/4" Insulated**A-F3617I** 17 3/4" x 21" Insulated**A-F36178I** 17 3/4" x 28 1/4" Insulated**A-F3621I** 21 1/4" x 21" Insulated**A-F36218I** 21 3/4" x 28 1/4" Insulated**A-F3614** 14 5/8" x 28 1/4"**A-F3617** 17 3/4" x 28 1/4"**A-F3621** 21 1/4" x 28 1/4"

**Furnace Accessories****Columbia Base Cans Furnace with End Cap 44" Tall, 24 Gauge**

<b>A-F4414I</b>	14 5/8" x 21" Insulated
<b>A-F4417I</b>	17 3/4" x 21" Insulated
<b>A-F4421I</b>	21 1/4" x 21" Insulated
<b>A-F4414</b>	14 5/8" x 21"
<b>A-F4417</b>	17 3/4" x 21"
<b>A-F4421</b>	21 1/4" x 21"
<b>A-F4424</b>	24 3/4" x 21"

**Columbia Downflow Subbases**

<b>A-DS18</b>	18 1/2" x 20 1/2" x 5" High
<b>A-DS23</b>	23 1/2" x 21" x 5" High
<b>A-DS26</b>	26" x 21" x 5" High
<b>A-DS14</b>	14 5/8" x 28 1/4" x 5" High
<b>A-DS14W</b>	14 5/8" x 28 1/4" x 5" High w/ 2" Ins.
<b>A-DS17</b>	17 3/4" x 28 1/4" x 5" High
<b>A-DS17W</b>	17 3/4" x 28 1/4" x 5" High w/ 2" Ins.
<b>A-DS21</b>	21 1/4" x 28 1/4" x 5" High
<b>A-DS21W</b>	21 1/4" x 28 1/4" x 5" High w/ 2" Ins.
<b>A-DS24</b>	24 3/4" x 28 1/4" x 5" High
<b>A-DS24W</b>	24 3/4" x 28 1/4" x 5" High w/ 2" Ins.

**Columbia Filter Access Panel**

<b>A-FAP16</b>	16" Filter Access Panel
<b>A-FAP20</b>	20" Filter Access Panel

**Furnace Accessories****Columbia Filter Racks**

<b>A-FR16</b>	16" x 20"
<b>A-FR16H</b>	16" x 20" (3" High)
<b>A-FR165</b>	16" x 25"
<b>A-FR20</b>	20" x 20"
<b>A-FR20H</b>	20" x 20" (3" High)
<b>A-FR205</b>	20" x 25"
<b>A-FR205H</b>	20" x 25" (3" High)

**Columbia Plenum Drops**

<b>A-PD8DS14</b>	18" Tall - Drop for DS14
<b>A-PD8DS17</b>	18" Tall - Drop for DS17
<b>A-PD8DS21</b>	18" Tall - Drop for DS21
<b>A-PD8DS24</b>	18" Tall - Drop for DS24
<b>A-DS8AH18</b>	18" Tall - Drop for DS AH 18
<b>A-DS8AH21</b>	18" Tall - Drop for DS AH 21
<b>A-DS8AH23</b>	18" Tall - Drop for DS AH 23
<b>A-DS8AH26</b>	18" Tall - Drop for DS AH 26

**Furnace Accessories****Columbia Plenum Drops**

<b>A-PD6DS14</b>	36" Tall - Drop for DS14
<b>A-PD6DS17</b>	36" Tall - Drop for DS17
<b>A-PD6DS21</b>	36" Tall - Drop for DS21
<b>A-PD6DS24</b>	36" Tall - Drop for DS24
<b>A-PD6AH18</b>	36" Tall - Drop for DS AH 18
<b>A-PD6AH21</b>	36" Tall - Drop for DS AH 21
<b>A-PD6AH23</b>	36" Tall - Drop for DS AH 23
<b>A-PD6AH26</b>	36" Tall - Drop for DS AH 26

**Columbia Plenums 24" Tall, 26 Gauge**

<b>A-PL13I</b>	13 1/2" x 19 7/8" Insulated
<b>A-PL16I</b>	16 1/2" x 19 7/8" Insulated
<b>A-PL20I</b>	20" x 19 7/8" Insulated
<b>A-PL23I</b>	23 1/2" x 19 7/8" Insulated
<b>A-PL13</b>	13 1/2" x 19 7/8"
<b>A-PL16</b>	16 1/2" x 19 7/8"
<b>A-PL20</b>	20" x 19 7/8"
<b>A-PD23</b>	23 1/2" x 19 7/8"

**Columbia Plenums with Filter Access Panel 24" Tall, 26 Gauge**

<b>A-PLP413I</b>	13 1/2" x 19 7/8" Insulated
<b>A-PLP416I</b>	16 1/2" x 19 7/8" Insulated
<b>A-PLP420I</b>	20" x 19 7/8" Insulated
<b>A-PLP423I</b>	23 1/2" x 19 7/8" Insulated



**Furnace Accessories****Columbia Plenums with Filter Access Panel 24" Tall, 26 Gauge****A-PLP413** 13 1/2" x 19 7/8"**A-PLP416** 16 1/2" x 19 7/8"**A-PLP420** 20" x 19 7/8"**A-PLP423** 23 1/2" x 19 7/8"**Columbia Plenums with Filter Access Panel 36" Tall, 26 Gauge****A-PLP613I** 13 1/2" x 19 7/8" Insulated**A-PLP616I** 16 1/2" x 19 7/8" Insulated**A-PLP6205I** 20" x 25" Insulated**A-PLP6209I** 20" x 19 7/8" Insulated**A-PLP613** 13 1/2" x 19 7/8"**A-PLP616** 16 1/2" x 19 7/8"**A-PLP620** 20" x 19 7/8"**Columbia Plenums - Air Handlers****A-AH1844** 18 3/4" x 14" x 24" Tall Supply**A-AH1846** 18 3/4" x 14" x 36" Tall Supply**A-AH1924** 19 3/4" x 12 1/2" x 24" Tall Supply**A-AH1926** 19 3/4" x 12 1/2" x 36" Tall Supply**A-AH2124** 21 3/4" x 12 1/2" x 24" Tall Supply**A-AH2126** 21 3/4" x 12 1/2" x 36" Tall Supply**A-AH2424** 24 1/4" x 12 1/2" x 24" Tall Supply**A-AH2426** 24 1/4" x 12 1/2" x 36" Tall Supply

**Furnace Accessories****Columbia Plenums - Air Handlers**

<b>A-AH1974</b>	19 1/4" x 17 1/2" x 24" Tall Return
<b>A-AH1976</b>	19 1/4" x 17 1/2" x 36" Tall Return
<b>A-AH2094</b>	20 1/4" x 19 1/2" x 24" Tall Return
<b>A-AH2096</b>	20 1/4" x 19 1/2" x 36" Tall Return
<b>A-AH2294</b>	22 1/4" x 19 1/2" x 24" Tall Return
<b>A-AH2296</b>	22 1/4" x 19 1/2" x 36" Tall Return
<b>A-AH2494</b>	24 3/4" x 19 1/2" x 24" Tall Return
<b>A-AH2496</b>	24 3/4" x 19 1/2" x 36" Tall Return

### Oval Products

#### Columbia Oval Boots

<b>A-OB906</b>	90° - 6"
<b>A-OB9076</b>	90° - 7" Oval to 6" Round
<b>A-OB907</b>	90° - 7"
<b>A-OB908</b>	90° - 8"
<b>A-OBBS</b>	Boot Stackhead 4" x 10" to 6"
<b>A-OBRTB</b>	7" Oval to 6" Round Torpedo Boot
<b>A-OB7TB</b>	7" Torpedo Boot
<b>A-OB6S</b>	6" Straight Oval Boot w/ Straight Back
<b>A-OB7S</b>	7" Straight Oval Boot w/ Straight Back
<b>A-OB8S</b>	8" Straight Oval Boot w/ Straight Back
<b>A-OB6A</b>	6" Straight Oval Boot w/ Angled Back
<b>A-OB7RS</b>	7" Oval to 6" Round Straight Boot
<b>A-OB7SA</b>	7" Straight Oval Boot w/ Angled Back
<b>A-OB8SA</b>	8" Straight Oval Boot w/ Angled Back



#### Columbia Oval Elbows

<b>A-OE645S</b>	6" 45° Standard
<b>A-OE645F</b>	6" 45° Flat
<b>A-OE645ST</b>	6" 45° Special Throat Angle
<b>A-OE6</b>	6" Standard
<b>A-OEBS</b>	Boot Stackhead 4" x 10" to 6"
<b>A-OE745S</b>	7" 45° Standard
<b>A-OE745F</b>	7" 45° Flat
<b>A-OE45S</b>	8" 45° Standard
<b>A-OE845F</b>	8" 45° Flat

**Oval Products****Columbia Oval End Caps****A-OEC6** 6"**A-OEC7** 7"**A-OEC8** 8"**Columbia Oval Pipe Wallstack****A-OW68** 6" x 8' (per ft.)**A-OW78** 7" x 8' (per ft.)**A-OW88** 8" x 8' (per ft.)**A-OW61** 6" x 102" (each)**A-OW65** 6" x 5' (per ft.)**A-OW71** 7" x 102" (each)**A-OW75** 7" x 5' (per ft.)**A-OW81** 8" x 102" (each)**A-OW85** 8" x 5' (per ft.)

### Round Pipe

Columbia Round Pipe - Snap Lock	
<b>A-SL032</b> 30 Gauge - 3" Round 2'	<b>A-SL075</b> 30 Gauge - 7" Round 5'
<b>A-SL035</b> 30 Gauge - 3" Round 5'	<b>A-SL080</b> 30 Gauge - 8" Round 10'
<b>A-SL042</b> 30 Gauge - 4" Round 2'	<b>A-SL082</b> 30 Gauge - 8" Round 2'
<b>A-SL045</b> 30 Gauge - 4" Round 5'	<b>A-SL085</b> 30 Gauge - 8" Round 5'
<b>A-SL050</b> 30 Gauge - 5" Round 10'	<b>A-SL092</b> 30 Gauge - 9" Round 2'
<b>A-SL052</b> 30 Gauge - 5" Round 2'	<b>A-SL095</b> 30 Gauge - 9" Round 5'
<b>A-SL055</b> 30 Gauge - 5" Round 5'	<b>A-SL000</b> 30 Gauge - 10" Round 10'
<b>A-SL060</b> 30 Gauge - 6" Round 10'	<b>A-SL002</b> 30 Gauge - 10" Round 2'
<b>A-SL060U</b> 30 Gauge - 6" Rnd. 10', Unbeaded	<b>A-SL005</b> 30 Gauge - 10" Round 5'
<b>A-SL062</b> 30 Gauge - 6" Round 2'	<b>A-SL022</b> 30 Gauge - 12" Round 2'
<b>A-SL065</b> 30 Gauge - 6" Round 5'	<b>A-SL025</b> 30 Gauge - 12" Round 5'
<b>A-SL070</b> 30 Gauge - 7" Round 10'	<b>A-SL0142</b> 30 Gauge - 14" Round 2'
<b>A-SL072</b> 30 Gauge - 7" Round 2'	<b>A-SL0145</b> 30 Gauge - 14" Round 5'
.....	
<b>A-SLA32</b> Aluminum - 3" Round 2'	<b>A-SLA62</b> Aluminum - 6" Round 2'
<b>A-SLA42</b> Aluminum - 4" Round 2'	<b>A-SLA72</b> Aluminum - 7" Round 2'
<b>A-SLA52</b> Aluminum - 5" Round 2'	<b>A-SLA82</b> Aluminum - 8" Round 2'
.....	
<b>A-SL452</b> 24 Gauge - 5" Round 2'	<b>A-SL482</b> 24 Gauge - 8" Round 2'
<b>A-SL455</b> 24 Gauge - 5" Round 5'	<b>A-SL485</b> 24 Gauge - 8" Round 5'
<b>A-SL462</b> 24 Gauge - 6" Round 2'	<b>A-SL492</b> 24 Gauge - 9" Round 2'
<b>A-SL465</b> 24 Gauge - 6" Round 5'	<b>A-SL495</b> 24 Gauge - 9" Round 5'
<b>A-SL472</b> 24 Gauge - 7" Round 2'	<b>A-SL402</b> 24 Gauge - 10" Round 2'
<b>A-SL475</b> 24 Gauge - 7" Round 5'	<b>A-SL405</b> 24 Gauge - 10" Round 5'

**Round Pipe**

Columbia Round Pipe - Snap Lock	
<b>A-SL422</b> 24 Gauge - 12" Round 2'	<b>A-SL4182</b> 24 Gauge - 18" Round 2'
<b>A-SL425</b> 24 Gauge - 12" Round 5'	<b>A-SL4185</b> 24 Gauge - 18" Round 5'
<b>A-SL4142</b> 24 Gauge - 14" Round 2'	<b>A-SL4202</b> 24 Gauge - 20" Round 2'
<b>A-SL4145</b> 24 Gauge - 14" Round 5'	<b>A-SL4225</b> 24 Gauge - 22" Round 5'
<b>A-SL4162</b> 24 Gauge - 16" Round 2'	<b>A-SL4242</b> 24 Gauge - 24" Round 2'
<b>A-SL4165</b> 24 Gauge - 16" Round 5'	
.....	
<b>A-SL632</b> 26 Gauge - 3" Round 2'	<b>A-SL692</b> 26 Gauge - 9" Round 2'
<b>A-SL635</b> 26 Gauge - 3" Round 5'	<b>A-SL695</b> 26 Gauge - 9" Round 5'
<b>A-SL642</b> 26 Gauge - 4" Round 2'	<b>A-SL602</b> 26 Gauge - 10" Round 2'
<b>A-SL645</b> 26 Gauge - 4" Round 5'	<b>A-SL605</b> 26 Gauge - 10" Round 5'
<b>A-SL652</b> 26 Gauge - 5" Round 2'	<b>A-SL622</b> 26 Gauge - 12" Round 2'
<b>A-SL655</b> 26 Gauge - 5" Round 5'	<b>A-SL625</b> 26 Gauge - 12" Round 5'
<b>A-SL662</b> 26 Gauge - 6" Round 2'	<b>A-SL6142</b> 26 Gauge - 14" Round 2'
<b>A-SL665</b> 26 Gauge - 6" Round 5'	<b>A-SL6145</b> 26 Gauge - 14" Round 5'
<b>A-SL672</b> 26 Gauge - 7" Round 2'	<b>A-SL6162</b> 26 Gauge - 16" Round 2'
<b>A-SL675</b> 26 Gauge - 7" Round 5'	<b>A-SL6165</b> 26 Gauge - 16" Round 5'
<b>A-SL682</b> 26 Gauge - 8" Round 2'	<b>A-SL6182</b> 26 Gauge - 18" Round 2'
<b>A-SL685</b> 26 Gauge - 8" Round 5'	

**Down Spout**

<b>A-CP03</b> 30 Gauge - 3" x 10"
<b>A-CP63</b> 26 Gauge - 3" x 10' Spiral Downspout
<b>A-CP64</b> 26 Gauge - 4" x 10' Spiral Downspout

### Adjustable Elbows

#### Columbia 45° Elbows

<b>A-45E45</b> 24 Gauge - 5" Round	<b>A-45E414</b> 24 Gauge - 14" Round
<b>A-45E46</b> 24 Gauge - 6" Round	<b>A-45E416</b> 24 Gauge - 16" Round
<b>A-45E47</b> 24 Gauge - 7" Round	<b>A-45E418</b> 24 Gauge - 18" Round
<b>A-45E48</b> 24 Gauge - 8" Round	<b>A-45E420</b> 24 Gauge - 20" Round
<b>A-45E49</b> 24 Gauge - 9" Round	<b>A-45E422</b> 24 Gauge - 22" Round
<b>A-45E40</b> 24 Gauge - 10" Round	<b>A-45E424</b> 24 Gauge - 24" Round
<b>A-45E412</b> 24 Gauge - 12" Round	
.....	
<b>A-45E64</b> 26 Gauge - 4" Round	<b>A-45E69</b> 26 Gauge - 9" Round
<b>A-45E65</b> 26 Gauge - 5" Round	<b>A-45E60</b> 26 Gauge - 10" Round
<b>A-45E66</b> 26 Gauge - 6" Round	<b>A-45E612</b> 26 Gauge - 12" Round
<b>A-45E67</b> 26 Gauge - 7" Round	<b>A-45E614</b> 26 Gauge - 14" Round
<b>A-45E68</b> 26 Gauge - 8" Round	<b>A-45E616</b> 26 Gauge - 16" Round

#### Columbia 90° Elbows

<b>A-90E45</b> 24 Gauge - 5" Round	<b>A-90E414</b> 24 Gauge - 14" Round
<b>A-90E46</b> 24 Gauge - 6" Round	<b>A-90E416</b> 24 Gauge - 16" Round
<b>A-90E47</b> 24 Gauge - 7" Round	<b>A-90E418</b> 24 Gauge - 18" Round
<b>A-90E48</b> 24 Gauge - 8" Round	<b>A-90E420</b> 24 Gauge - 20" Round
<b>A-90E49</b> 24 Gauge - 9" Round	<b>A-90E422</b> 24 Gauge - 22" Round
<b>A-90E40</b> 24 Gauge - 10" Round	<b>A-90ER24</b> 24 Gauge - 24" Round
<b>A-90E412</b> 24 Gauge - 12" Round	

**Adjustable Elbows**

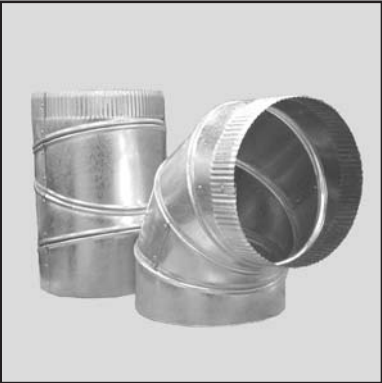
Columbia 90° Elbows	
<b>A-90E63</b> 26 Gauge - 3" Round	<b>A-90E69</b> 26 Gauge - 9" Round
<b>A-90E64</b> 26 Gauge - 4" Round	<b>A-90E60</b> 26 Gauge - 10" Round
<b>A-90E65</b> 26 Gauge - 5" Round	<b>A-90E612</b> 26 Gauge - 12" Round
<b>A-90E66</b> 26 Gauge - 6" Round	<b>A-90E614</b> 26 Gauge - 14" Round
<b>A-90E67</b> 26 Gauge - 7" Round	<b>A-90E616</b> 26 Gauge - 16" Round
<b>A-90E68</b> 26 Gauge - 8" Round	
<hr/>	
<b>A-90E03</b> 30 Gauge - 3" Round	
<b>A-90E04</b> 30 Gauge - 4" Round	
<b>A-90E05</b> 30 Gauge - 5" Round	
<b>A-90E06B</b> 30 Gauge - 6" Round, Bent	
<b>A-90E06S</b> 30 Gauge - 6" Round, Straight	
<b>A-90E07</b> 30 Gauge - 7" Round	
<b>A-90E08</b> 30 Gauge - 8" Round	
<b>A-90E09</b> 30 Gauge - 9" Round	
<b>A-90E00</b> 30 Gauge - 10" Round	
	<b>A-90E014</b> 30 Gauge - 14" Round

**Columbia 90° Vent Elbows - Aluminum**

<b>A-VE3</b> 3" Round
<b>A-VE4</b> 4" Round
<b>A-VE5</b> 5" Round
<b>A-VE6</b> 6" Round
<b>A-VE7</b> 7" Round
<b>A-VE8</b> 8" Round



### Register, Specialty & Miscellaneous Boots

#### Columbia Register Boots with Dampers and Extended Collars

<b>A-RBD405S</b>	Straight - 4" x 10" x 5"	<b>A-RBD427S</b>	Straight - 4" x 12" x 7"
<b>A-RBD406S</b>	Straight - 4" x 10" x 6"	<b>A-RBD447S</b>	Straight - 4" x 14" x 7"
<b>A-RBD426S</b>	Straight - 4" x 12" x 6"	<b>A-RBD448S</b>	Straight - 4" x 14" x 8"
.....			
<b>A-RBD405A</b>	90° Ang. - 4" x 10" x 5"	<b>A-RBD427A</b>	90° Ang.- 4" x 12" x 7"
<b>A-RBD406A</b>	90° Ang. - 4" x 10" x 6"	<b>A-RBD447A</b>	90° Ang.- 4" x 14" x 7"
<b>A-RBD426A</b>	90° Ang. - 4" x 12" x 6"	<b>A-RBD448A</b>	90° Ang.- 4" x 14" x 8"
.....			
<b>A-RBD405E</b>	End Boot- 4" x 10" x 5"	<b>A-RBD427E</b>	End Boot- 4" x 12" x 7"
<b>A-RBD406E</b>	End Boot- 4" x 10" x 6"	<b>A-RBD447E</b>	End Boot- 4" x 14" x 7"
<b>A-RBD426E</b>	End Boot- 4" x 12" x 6"	<b>A-RBD448E</b>	End Boot- 4" x 14" x 8"

**Register, Specialty & Miscellaneous Boots**

Columbia P Series Register Boots	
<b>A-RBP204S</b> Straight - 2 1/4" x 10" x 4"	<b>A-RBP428S</b> Straight - 4" x 12" x 8"
<b>A-RBP205S</b> Straight - 2 1/4" x 10" x 5"	<b>A-RBP446S</b> Straight - 4" x 14" x 6"
<b>A-RBP206S</b> Straight - 2 1/4" x 10" x 6"	<b>A-RBP447S</b> Straight - 4" x 14" x 7"
<b>A-RBP225S</b> Straight - 2 1/4" x 12" x 5"	<b>A-RBP448S</b> Straight - 4" x 14" x 8"
<b>A-RBP226S</b> Straight - 2 1/4" x 12" x 6"	<b>A-RBP606S</b> Straight - 6" x 10" x 6"
<b>A-RBP246S</b> Straight - 2 1/4" x 14" x 6"	<b>A-RBP607S</b> Straight - 6" x 10" x 7"
<b>A-RBP404S</b> Straight - 4" x 10" x 4"	<b>A-RBP626S</b> Straight - 6" x 12" x 6"
<b>A-RBP405S</b> Straight - 4" x 10" x 5"	<b>A-RBP627S</b> Straight - 6" x 12" x 7"
<b>A-RBP406S</b> Straight - 4" x 10" x 6"	<b>A-RBP628S</b> Straight - 6" x 12" x 8"
<b>A-RBP407S</b> Straight - 4" x 10" x 7"	<b>A-RBP647S</b> Straight - 6" x 14" x 7"
<b>A-RBP425S</b> Straight - 4" x 12" x 5"	<b>A-RBP648S</b> Straight - 6" x 14" x 8"
<b>A-RBP426S</b> Straight - 4" x 12" x 6"	<b>A-RBP649S</b> Straight - 6" x 14" x 9"
<b>A-RBP427S</b> Straight - 4" x 12" x 7"	
.....	
<b>A-RBP204A</b> 90° Ang. - 2 1/4" x 10" x 4"	<b>A-RBP425A</b> 90° Ang. - 4" x 12" x 5"
<b>A-RBP205A</b> 90° Ang. - 2 1/4" x 10" x 5"	<b>A-RBP426A</b> 90° Ang. - 4" x 12" x 6"
<b>A-RBP206A</b> 90° Ang. - 2 1/4" x 10" x 6"	<b>A-RBP427A</b> 90° Ang. - 4" x 12" x 7"
<b>A-RBP225A</b> 90° Ang. - 2 1/4" x 12" x 5"	<b>A-RBP428A</b> 90° Ang. - 4" x 12" x 8"
<b>A-RBP226A</b> 90° Ang. - 2 1/4" x 12" x 6"	<b>A-RBP446A</b> 90° Ang. - 4" x 14" x 6"
<b>A-RBP246A</b> 90° Ang. - 2 1/4" x 14" x 6"	<b>A-RBP447A</b> 90° Ang. - 4" x 14" x 7"
<b>A-RBP404A</b> 90° Ang. - 4" x 10" x 4"	<b>A-RBP448A</b> 90° Ang. - 4" x 14" x 8"
<b>A-RBP405A</b> 90° Ang. - 4" x 10" x 5"	<b>A-RBP606A</b> 90° Ang. - 6" x 10" x 6"
<b>A-RBP406A</b> 90° Ang. - 4" x 10" x 6"	<b>A-RBP607A</b> 90° Ang. - 6" x 10" x 7"
<b>A-RBP407A</b> 90° Ang. - 4" x 10" x 7"	<b>A-RBP626A</b> 90° Ang. - 6" x 12" x 6"

### Register, Specialty & Miscellaneous Boots

Columbia P Series Register Boots			
<b>A-RBP627A</b>	90° Ang. - 6" x 12" x 7"	<b>A-RBP648A</b>	90° Ang. - 6" x 14" x 8"
<b>A-RBP628A</b>	90° Ang. - 6" x 12" x 8"	<b>A-RBP648A</b>	90° Ang. - 6" x 14" x 9"
<b>A-RBP647A</b>	90° Ang. - 6" x 14" x 7"		
.....			
<b>A-RBP204E</b>	End Boot- 2 1/4" x 10" x 4"	<b>A-RBP425E</b>	End Boot - 4" x 12" x 5"
<b>A-RBP205E</b>	End Boot- 2 1/4" x 10" x 5"	<b>A-RBP426E</b>	End Boot - 4" x 12" x 6"
<b>A-RBP200E</b>	End Boot- 2 1/4" x 10" x 6"	<b>A-RBP427E</b>	End Boot - 4" x 12" x 7"
<b>A-RBP225E</b>	End Boot- 2 1/4" x 12" x 5"	<b>A-RBP428E</b>	End Boot - 4" x 12" x 8"
<b>A-RBP225E</b>	End Boot- 2 1/4" x 12" x 6"	<b>A-RBP446E</b>	End Boot - 4" x 14" x 6"
<b>A-RBP246E</b>	End Boot- 2 1/4" x 14" x 6"	<b>A-RBP447E</b>	End Boot - 4" x 14" x 7"
<b>A-RBP404E</b>	End Boot- 4" x 10" x 4"	<b>A-RBP448E</b>	End Boot - 4" x 14" x 8"
<b>A-RBP405E</b>	End Boot- 4" x 10" x 5"	<b>A-RBP607E</b>	End Boot - 6" x 10" x 7"
<b>A-RBP406E</b>	End Boot- 4" x 10" x 6"	<b>A-RBP628E</b>	End Boot - 6" x 12" x 8"
<b>A-RBP407E</b>	End Boot - 4" x 10" x 7"	<b>A-RBP648E</b>	End Boot - 6" x 14" x 8"

Columbia Register Boots with Extended Collars	
<b>A-RBC406S</b>	Straight - 4" x 10" x 6"
<b>A-RBC427S</b>	Straight - 4" x 12" x 7"
<b>A-RBC448S</b>	Straight - 4" x 14" x 8"
<b>A-RBC648S</b>	Straight - 6" x 14" x 8"
<b>A-RBC648A</b>	90° Angled - 4" x 10" x 6"

**Register, Specialty & Miscellaneous Boots****Columbia Register Boots with Extended Collars & Boot Lock**

X = extended collar

<b>A-RBB406S</b>	Straight - 4" x 10" x 6"	<b>A-RBB426SX</b>	Straight - 4" x 12" x 6"
<b>A-RBB448S</b>	Straight - 4" x 14" x 8"	<b>A-RBB427SX</b>	Straight - 4" x 12" x 7"
<b>A-RBB406SX</b>	Straight - 4" x 10" x 6"	<b>A-RBB448SX</b>	Straight - 4" x 14" x 8"
<b>A-RBB4054AX</b>	45° Ang. - 4" x 10" x 5"	<b>A-RBB4274AX</b>	45° Ang. - 4" x 12" x 7"
<b>A-RBB4064AX</b>	45° Ang. - 4" x 10" x 6"	<b>A-RBB4484AX</b>	45° Ang. - 4" x 14" x 8"
<b>A-RBB4264AX</b>	45° Ang. - 4" x 12" x 6"		
<b>A-RBB4069AX</b>	90° Ang - 4" x 10" x 6"	<b>A-RBB4269AX</b>	90° Ang.- 4" x 12" x 6"
<b>A-RBB4489AX</b>	90° Ang.- 4" x 14" x 8"	<b>A-RBB4279AX</b>	90° Ang.- 4" x 12" x 7"
<b>A-RBB4069AX</b>	90° Ang.- 4" x 10" x 6"	<b>A-RBB4489AX</b>	90° Ang.- 4" x 14" x 8"

**Columbia 45° Flex Boots**

<b>A-FB206</b>	2 1/4" x 10" x 6"
<b>A-FB405</b>	4" x 10" x 5"
<b>A-FB406</b>	4" x 10" x 6"
<b>A-FB407</b>	4" x 10" x 7"
<b>A-FB426</b>	4" x 12" x 6"
<b>A-FB427</b>	4" x 12" x 7"
<b>A-FB448</b>	4" x 14" x 8"

**Register, Specialty & Miscellaneous Boots****Columbia Ceiling Boots**

<b>A-CB626S</b>	Straight - 6" x 12" x 6" Collar w/C-Box Flange, 6" Throat
<b>A-CB627S</b>	Straight - 6" x 12" x 7" Collar w/C-Box Flange, 6" Throat
<b>A-CB628S</b>	Straight - 6" x 12" x 8" Collar w/C-Box Flange, 6" Throat
<b>A-CB648S</b>	Straight - 6" x 14" x 8" Collar w/C-Box Flange, 6" Throat
<b>A-CB625A</b>	90° Angled - 6" x 12" x 5" Collar w/C-Box Flange, 6" Throat
<b>A-CB626A</b>	90° Angled - 6" x 12" x 6" Collar w/C-Box Flange, 6" Throat
<b>A-CB627A</b>	90° Angled - 6" x 12" x 7" Collar w/C-Box Flange, 6" Throat
<b>A-CB628A</b>	90° Angled - 6" x 12" x 8" Collar w/C-Box Flange, 6" Throat

**Columbia Offset Torpedo End Register Boot**

<b>A-TEBL</b>	Straight on Left - 4" x 12" x 6"
<b>A-TEBR</b>	Straight on Right - 4" x 12" x 6"

**Columbia Specialty Boots**

<b>A-SB226</b>	2 1/4" x 12" x 6"
<b>A-SB406</b>	4" x 10" x 6"
<b>A-SB426</b>	4" x 12" x 6"

**Columbia Kitchen Fan Boot**

<b>A-KFB</b>	3 1/4" x 10" x 6" Collar
--------------	--------------------------

**Columbia Straight Boot Less Collar**

<b>A-SBL406</b>	4" x 10" x 6"
<b>A-SBL426</b>	4" x 12" x 6"
<b>A-SBL427</b>	4" x 12" x 7"

**Register, Specialty & Miscellaneous Boots****Columbia Straight Boot - Less Collar with Flange****A-SBF206** 2 1/4" x 10" x 6"**A-SBF226** 2 1/4" x 12" x 6"**A-SBF406** 4" x 10" x 6"**A-SBF4064** 4" x 10" x 6 1/4"**A-SBF427** 4" x 12" x 7"**A-SBF448** 4" x 14" x 8"**Columbia Boot Accessories****A-BABL** 5' Boot Lock 30GA**A-BAPG** 10' Plaster Ground 26GA**Columbia Register Boots with 2" Throat**

<b>A-RBT206S</b> Straight - 2 1/4" x 10" x 6"	<b>A-RBT406S</b> Straight - 4" x 10" x 6"
<b>A-RBT226S</b> Straight - 2 1/4" x 12" x 6"	<b>A-RBT426S</b> Straight - 4" x 12" x 6"
<b>A-RBT246S</b> Straight - 2 1/4" x 14" x 6"	
<b>A-RBT205A</b> 90° Ang. - 2 1/4" x 10" x 5"	<b>A-RBT406A</b> 90° Ang. - 4" x 10" x 6"
<b>A-RBT206A</b> 90° Ang. - 2 1/4" x 10" x 6"	<b>A-RBT426A</b> 90° Ang. - 4" x 12" x 6"
<b>A-RBT226A</b> 90° Ang. - 2 1/4" x 12" x 6"	<b>A-RBT427A</b> 90° Ang. - 4" x 12" x 7"
<b>A-RBT246A</b> 90° Ang. - 2 1/4" x 14" x 6"	
<b>A-RBT206T</b> Torp. End- 2 1/4" x 10" x 6"	<b>A-RBT406T</b> Torp. End- 4" x 10" x 6"
<b>A-RBT226T</b> Torp. End- 2 1/4" x 12" x 6"	<b>A-RBT426T</b> Torp. End- 4" x 12" x 6"
<b>A-RBT246T</b> Torp. End- 2 1/4" x 14" x 6"	

### Take Offs

Columbia Air Tight Take Offs			
<b>A-TO5</b>	5"		
<b>A-TO6</b>	6"		
<b>A-TO690</b>	6" - 90° Take Off		
<b>A-TO6D</b>	6" w/ Damper		
<b>A-TO7</b>	7"		
<b>A-TO790</b>	7" - 90° Take Off		
<b>A-TO7D</b>	7" w/ Damper		
<b>A-TO8</b>	8"	<b>A-TO10D</b>	10" w/ Damper
<b>A-TO890</b>	8" - 90° Take Off	<b>A-TO12</b>	12"
<b>A-TO8D</b>	8" w/ Damper	<b>A-TO12D</b>	12" w/ Damper
<b>A-TO9</b>	9"	<b>A-TO14</b>	14"
<b>A-TO9D</b>	9" w/ Damper	<b>A-TO14D</b>	14" w/ Damper
<b>A-TO10</b>	10"	<b>A-TO16</b>	16"

### Wall Stack

Columbia Wall Stack Fittings	
<b>A-WSF10</b>	3 1/4" x 10" w/ 6" x 10" Register Opening
<b>A-WSF12</b>	3 1/4" x 12" w/ 6" x 12" Register Opening
<b>A-WSF14</b>	3 1/4" x 14" w/ 6" x 14" Register Opening
.....	
<b>A-WSFTO</b>	6" Double Top Take-Off

**Wall Stack****Columbia Wall Stack Fittings****A-WSF1045S** 3 1/4" x 10" 45° SW**A-WSF1245S** 3 1/4" x 12" 45° SW**A-WSF1445S** 3 1/4" x 14" 45° SW**A-WSF1045L** 3 1/4" x 10" 45° LW**A-WSF1245L** 3 1/4" x 12" 45° LW**A-WSF1445L** 3 1/4" x 14" 45° LW**A-WSF1090S** 3 1/4" x 10" 90° SW**A-WSF1290S** 3 1/4" x 12" 90° SW**A-WSF1490S** 3 1/4" x 14" 90° SW**A-WSF1090L** 3 1/4" x 10" 90° LW**A-WSF1290L** 3 1/4" x 12" 90° LW**A-WSF1490L** 3 1/4" x 14" 90° LW**Columbia Wall Stack****A-WS1016** 3 1/4" x 10" x 16"**A-WS1030** 3 1/4" x 10" x 30"**A-WS1010** 3 1/4" x 10" x 102"**A-WS105** 3 1/4" x 10" x 5'**A-WS108** 3 1/4" x 10" x 8'**A-WS1230** 3 1/4" x 12" x 30"**A-WS125** 3 1/4" x 12" x 5'**A-WS1430** 3 1/4" x 14" x 30"**A-WS145** 3 1/4" x 14" x 5'



### Wall Stack

#### Wall Stack Accessories

**A-WSAPS** 12GA 1.5" x 18" Nail Plate Strap

#### Columbia Wall Stack Boots

<b>A-WSB05S</b> Straight - 3 1/4" x 10" - 5" Collar	<b>A-WSB27S</b> Straight - 3 1/4" x 12" - 7" Collar
<b>A-WSB06S</b> Straight - 3 1/4" x 10" - 6" Collar	<b>A-WSB28S</b> Straight - 3 1/4" x 12" - 8" Collar
<b>A-WSB07S</b> Straight - 3 1/4" x 10" - 7" Collar	<b>A-WSB46S</b> Straight - 3 1/4" x 14" - 6" Collar
<b>A-WSB08S</b> Straight - 3 1/4" x 10" - 8" Collar	<b>A-WSB47S</b> Straight - 3 1/4" x 14" - 7" Collar
<b>A-WSB26S</b> Straight - 3 1/4" x 12" - 6" Collar	<b>A-WSB48S</b> Straight - 3 1/4" x 14" - 8" Collar
.....	
<b>A-WSB05A</b> 90° Ang. - 3 1/4" x 10" - 5" Collar	<b>A-WSB28A</b> 90° Ang.- 3 1/4" x 12" -8" Collar
<b>A-WSB06A</b> 90° Ang. - 3 1/4" x 10" - 6" Collar	<b>A-WSB46A</b> 90° Ang.- 3 1/4" x 14" -6" Collar
<b>A-WSB07A</b> 90° Ang.- 3 1/4" x 10" - 7" Collar	<b>A-WSB47A</b> 90° Ang.- 3 1/4" x 14" -7" Collar
<b>A-WSB26A</b> 90° Ang. - 3 1/4" x 12" - 6" Collar	<b>A-WSB48A</b> 90° Ang.- 3 1/4" x 14" -8" Collar
<b>A-WSB27A</b> 90° Ang. - 3 1/4" x 12" - 7" Collar	
.....	
<b>A-WSB05E</b> End Boot- 3 1/4" x 10" - 5" Collar	<b>A-WSB27E</b> End Boot- 3 1/4" x 12" - 7" Collar
<b>A-WSB06E</b> End Boot- 3 1/4" x 10" - 6" Collar	<b>A-WSB47E</b> End Boot- 3 1/4" x 14" - 7" Collar
<b>A-WSB07E</b> End Boot- 3 1/4" x 10" - 7" Collar	<b>A-WSB48E</b> End Boot- 3 1/4" x 14" - 8" Collar
<b>A-WSB26E</b> End Boot- 3 1/4" x 12" - 6" Collar	

## Duct Hanging Accessories

### Superstrut Angle Bracket & Fitting

**A-SABF**                  Angle Fitting

### Superstrut Cap Screws

**A-SCS**                   $\frac{3}{8}$ " x 1  $\frac{1}{2}$ "

### Superstrut Channel Nuts

**A-SCNUS**               $\frac{3}{8}$ " Universal Channel Nut with Spring

**A-SCN**                   $\frac{3}{8}$ " Channel Nut without Spring

### Superstrut Coach Rod Screws

**A-SCRS**                   $\frac{3}{8}$ " x 6"

### Superstrut Flat Washers

**A-SFW2**                   $\frac{1}{2}$ "

**A-SFW8**                   $\frac{3}{8}$ "

### Superstrut Hanging System - Channel

**A-SHS1258**              12 gauge Channel, 1  $\frac{5}{8}$ " x 1  $\frac{5}{8}$ " x 10'

**A-SHS1458**              14 gauge Channel, 1  $\frac{5}{8}$ " x  $\frac{13}{16}$ " x 10'

**A-SHS1238**              12 gauge Channel, 1  $\frac{3}{8}$ " x 1  $\frac{5}{8}$ " x 10'

### Superstrut Hex Nuts

**A-SHN12**                   $\frac{1}{2}$ "

**A-SHN14**                   $\frac{1}{4}$ "

**A-SHN38**                   $\frac{3}{8}$ "

**Duct Hanging Accessories****Superstrut Hex Rod Coupler**

<b>A-SHRC12</b>	1/2" EG
<b>A-SHRC14</b>	1/4" EG
<b>A-SHRC38</b>	3/8" EG

**Superstrut Lag Bolt**

<b>A-SLB</b>	3/8" x 2"
--------------	-----------

**Superstrut Threaded Rod**

<b>A-STR14</b>	1/4" EG Hex Rod Coupler
<b>A-STR38</b>	3/8" EG Hex Rod Coupler
<b>A-STR12</b>	1/2" EG Hex Rod Coupler

**Superstrut Cush-A-Clamps**

<b>A-SCC38</b>	3/8"
<b>A-SCC12</b>	1/2"
<b>A-SCC58</b>	5/8"
<b>A-SCC34</b>	3/4"
<b>A-SCC78</b>	7/8"
<b>A-SCC118</b>	1 1/8"
<b>A-SCC138</b>	1 3/8"
<b>A-SCC158</b>	1 5/8"
<b>A-SCC218</b>	2 1/8"
<b>A-SCC258</b>	2 5/8"

**Duct Hanging Accessories**

Superstrut Pipe Clamps

<b>A-SPC12</b>	1/2"
<b>A-SPC34</b>	3/4"
<b>A-SPC1</b>	1"
<b>A-SPC2</b>	2"

Superstrut Tube Clamps

<b>A-STC12</b>	1/2"
<b>A-STC58</b>	5/8"
<b>A-STC34</b>	3/4"
<b>A-STC78</b>	7/8"

Superstrut Clevis Hangers

<b>A-SCH12</b>	1/2" Standard
<b>A-SCH34</b>	3/4" Standard
<b>A-SCH1</b>	1" Standard
<b>A-SCH114</b>	1 1/4" Standard
<b>A-SCH112</b>	1 1/2" Standard
<b>A-SCH12L</b>	1/2" Light Duty
<b>A-SCH1L</b>	1" Light Duty
<b>A-SCH114L</b>	1 1/4" Light Duty

**Duct Hanging Accessories****Superstrut Swivel Pipe Hangers****A-SSPH12** 1/2"**A-SSPH34** 3/4"**A-SSPH1** 1"**A-SSPH114** 1 1/4"**A-SSPH112** 1 1/2"**A-SSPH2** 2"**A-SSPH212** 2 1/2"**Superstrut Parts****A-SP12SN** 1/2" Spring Nut**A-SP90F** 90° Fitting**A-SP38SW** 3/8" Square Washer**A-SPSP** Saddle Plate**A-SP38NS** 3/8" Nut Spring for B Series Channel**A-SP38BC** 3/8" Steel Beam Clamp

**Duct Hanging Accessories**

## Superstrut Parts

<b>A-SP14NCN</b>	1/4" Nylon Cone Nut
<b>A-SP38NCN</b>	3/8" Nylon Cone Nut
<b>A-SP12NCN</b>	1/2" Nylon Cone Nut
<b>A-SP12NCNB</b>	1/2" Nylon Cone Nut for B Channel
<b>A-SP14SC</b>	1/4" x 1 1/4" Screw Cap
<b>A-SP38SC</b>	3/8" x 1 1/4" Screw Cap
<b>A-SP12SC</b>	1/2" x 1 1/2" Screw Cap
<b>A-SP18HB</b>	1/8" x 1" Hex Head Bolt
<b>A-SP14W</b>	1/4" Washer
<b>A-SP38TR</b>	3/8" x 6' Threaded Rod
<b>A-SP38TBC</b>	3/8" Top Beam Clamp
<b>A-SP12TBC</b>	1/2" Top Beam Clamp
<b>A-SPSA</b>	Slotted Angle
<b>A-SPCAS</b>	Cush-A-Strip

**Access Doors**

## Insulated Access Doors



<b>A-IAD66</b>	6" x 6"
<b>A-IAD88</b>	8" x 8"
<b>A-IAD1010</b>	10" x 10"
<b>A-IAD1212</b>	12" x 12"
<b>A-IAD1616</b>	16" x 16"
<b>A-IAD2424</b>	24" x 24"

*"Proud Of Our Work!"*

**Access Doors****Ductmate Rectangular Duct Access Doors**

<b>A-RAD106</b>	10" x 6"
<b>A-RAD128</b>	12" x 8" Round
<b>A-RAD1814</b>	18" x 14"

**Ductmate Spiral Pipe Access Doors**

<b>A-SAD46</b>	4" x 8" Size to Fit (rd) 6"
<b>A-SAD49</b>	4" x 8" Size to Fit (rd) 9"
<b>A-SAD411</b>	4" x 8" Size to Fit (rd) 11"
<b>A-SAD214</b>	12" x 8" Round Size to Fit (rd) 14"
<b>A-SAD216</b>	12" x 8" Round Size to Fit (rd) 16"
<b>A-SAD218</b>	12" x 8" Round Size to Fit (rd) 18"
<b>A-SAD220</b>	12" x 8" Round Size to Fit (rd) 20"

**Ductmate Spiral Pipe Access Doors**

<b>A-SAD618</b>	16" x 12" Size to Fit (rd) 18"
<b>A-SAD620</b>	16" x 12" Size to Fit (rd) 20"
<b>A-SAD622</b>	16" x 12" Size to Fit (rd) 22"
<b>A-SAD624</b>	16" x 12" Size to Fit (rd) 24"
<b>A-SAD628</b>	16" x 12" Size to Fit (rd) 28"
<b>A-SAD632</b>	16" x 12" Size to Fit (rd) 32"
<b>A-SAD636</b>	16" x 12" Size to Fit (rd) 36"

**Ductmate Grease Duct Access Doors**

<b>A-GAD10</b>	10" x 6"
<b>A-GAD12</b>	12" x 8"
<b>A-GAD18</b>	18" x 14"

**Fire Dampers**

2650 Round Curtain-Type Fire Dampers

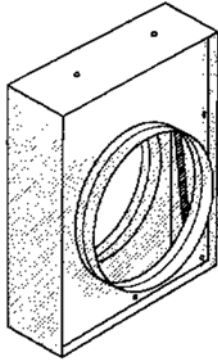
				
<b>A-RCD4</b>	4"	<b>A-RCD10</b>	10"	
<b>A-RCD5</b>	5"	<b>A-RCD12</b>	12"	
<b>A-RCD6</b>	6"	<b>A-RCD14</b>	14"	
<b>A-RCD7</b>	7"	<b>A-RCD16</b>	16"	
<b>A-RCD8</b>	8"	<b>A-RCD18</b>	18"	
<b>A-RCD9</b>	9"			

Smoke Fire Dampers - #132 120V Horz Vert R Mount

			
<b>A-SFD8</b>	8" x 8"	<b>A-SFD16</b>	16" x 16"
<b>A-SFD10</b>	10" x 10"	<b>A-SFD18</b>	18" x 18"
<b>A-SFD12</b>	12" x 12"	<b>A-SFD20</b>	20" x 20"
<b>A-SFD14</b>	14" x 14"	<b>A-SFD24</b>	24" x 24"

Square Ceiling Radiation Dampers

			
<b>A-SCRD6</b>	6" x 6"	<b>A-SCRD14</b>	14" x 14"
<b>A-SCRD8</b>	8" x 8"	<b>A-SCRD16</b>	16" x 16"
<b>A-SCRD10</b>	10" x 10"	<b>A-SCRD24</b>	24" x 24"
<b>A-SCRD12</b>	12" x 12"		



### Fire Dampers

#### Round Ceiling Radiation Dampers



<b>A-RCRD6</b>	6"	<b>A-RCRD12</b>	12"
<b>A-RCRD8</b>	8"	<b>A-RCRD14</b>	14"
<b>A-RCRD10</b>	10"	<b>A-RCRD16</b>	16"

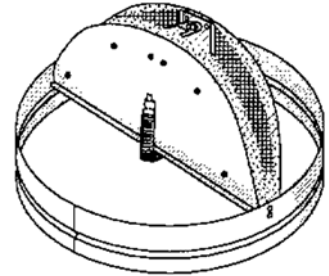

#### Square and Rectangular Fire Dampers



<b>A-RFDLF</b>	Link Fuse 165 Small	<b>A-RFD1410</b>	14" x 10"
<b>A-RFD66</b>	6" x 6"	<b>A-RFD1412</b>	14" x 12"
<b>A-RFD86</b>	8" x 6"	<b>A-RFD1414</b>	14" x 14"
<b>A-RFD88</b>	8" x 8"	<b>A-RFD168</b>	16" x 8"
<b>A-RFD104</b>	10" x 4"	<b>A-RFD1610</b>	16" x 10"
<b>A-RFD106</b>	10" x 6"	<b>A-RFD1612</b>	16" x 12"
<b>A-RFD108</b>	10" x 8"	<b>A-RFD1614</b>	16" x 14"
<b>A-RFD1010</b>	10" x 10"	<b>A-RFD1616</b>	16" x 16"
<b>A-RFD124</b>	12" x 4"	<b>A-RFD186</b>	18" x 6"
<b>A-RFD126</b>	12" x 6"	<b>A-RFD188</b>	18" x 8"
<b>A-RFD128</b>	12" x 8"	<b>A-RFD1810</b>	18" x 10"
<b>A-RFD1210</b>	12" x 10"	<b>A-RFD1812</b>	18" x 12"
<b>A-RFD1212</b>	12" x 12"	<b>A-RFD1814</b>	18" x 14"
<b>A-RFD146</b>	14" x 6"	<b>A-RFD1816</b>	18" x 16"
<b>A-RFD148</b>	14" x 8"	<b>A-RFD1818</b>	18" x 18"

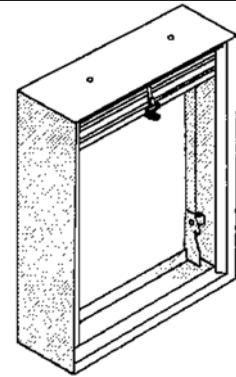

**Fire Dampers**

Square and Rectangular Fire Dampers



<b>A-RFD206</b>	20" x 6"	<b>A-RFD2412</b>	24" x 12"
<b>A-RFD208</b>	20" x 8"	<b>A-RFD2414</b>	24" x 14"
<b>A-RFD2010</b>	20" x 10"	<b>A-RFD2416</b>	24" x 16"
<b>A-RFD2012</b>	20" x 12"	<b>A-RFD2418</b>	24" x 18"
<b>A-RFD2014</b>	20" x 14"	<b>A-RFD2420</b>	24" x 20"
<b>A-RFD2016</b>	20" x 16"	<b>A-RFD2424</b>	24" x 24"
<b>A-RFD2018</b>	20" x 18"	<b>A-RFD306</b>	30" x 6"
<b>A-RFD2020</b>	20" x 20"	<b>A-RFD308</b>	30" x 8"
<b>A-RFD226</b>	22" x 6"	<b>A-RFD3010</b>	30" x 10"
<b>A-RFD228</b>	22" x 8"	<b>A-RFD3012</b>	30" x 12"
<b>A-RFD2210</b>	22" x 10"	<b>A-RFD3014</b>	30" x 14"
<b>A-RFD2222</b>	22" x 22"	<b>A-RFD3016</b>	30" x 16"
<b>A-RFD246</b>	24" x 6"	<b>A-RFD3018</b>	30" x 18"
<b>A-RFD248</b>	24" x 8"	<b>A-RFD3020</b>	30" x 20"
<b>A-RFD2410</b>	24" x 10"	<b>A-RFD3024</b>	30" x 24"

TTB Series Thermal Blanket



**A-TTB**                      28" x 28" Thermal Blanket

# Flex Duct, Insulation, Screws & Fasteners

Flex Duct.....	B2 - B4
Aluminum Flex Duct.....	B4
Dryer Hose.....	B5
Straps & Duct Hanging Accessories.....	B6 - B7
Duct Wrap.....	B7
Tape.....	B8
Fasteners.....	B8 - B9
Duct Sealer & Adhesives .....	B10
Access Door Handles & Damper Hardware.....	B11 - B15
Screws.....	B16
Rivets.....	B16 - B17
Miscellaneous.....	B17

**ROLOK** PRODUCTS



**DURO  
DYNE**

### Flex Duct

#### Flexible Duct GKM - R4.2

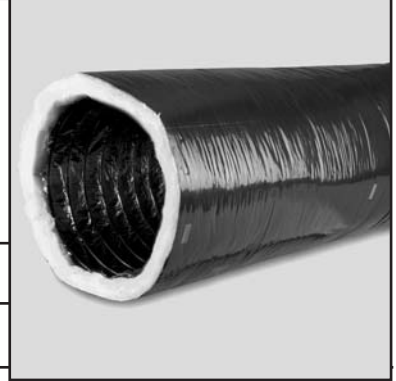

<b>B-GKM4</b>	4" x 25'	
<b>B-GKM5</b>	5" x 25'	
<b>B-GKM6</b>	6" x 25'	
<b>B-GKM7</b>	7" x 25'	
<b>B-GKM8</b>	8" x 25'	<b>B-GKM14</b> 14" x 25'
<b>B-GKM9</b>	9" x 25'	<b>B-GKM16</b> 16" x 25'
<b>B-GKM10</b>	10" x 25'	<b>B-GKM18</b> 18" x 25'
<b>B-GKM12</b>	12" x 25'	<b>B-GKM20</b> 20" x 25'

#### Flexible Duct MKE - R4.2

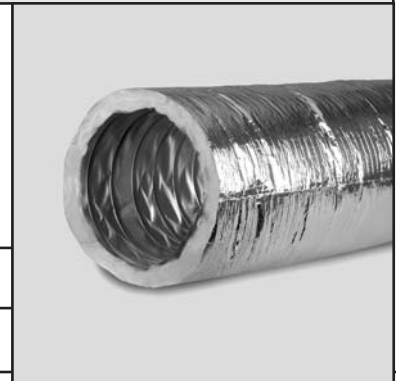

<b>B-MKE5</b>	5" x 25'	
<b>B-MKE6</b>	6" x 25'	
<b>B-MKE7</b>	7" x 25'	
<b>B-MKE8</b>	8" x 25'	
<b>B-MKE9</b>	9" x 25'	<b>B-MKE16</b> 16" x 25'
<b>B-MKE10</b>	10" x 25'	<b>B-MKE18</b> 18" x 25'
<b>B-MKE12</b>	12" x 25'	<b>B-MKE20</b> 20" x 25'
<b>B-MKE14</b>	14" x 25'	

**Flex Duct**

Flexible Duct SLP - 10

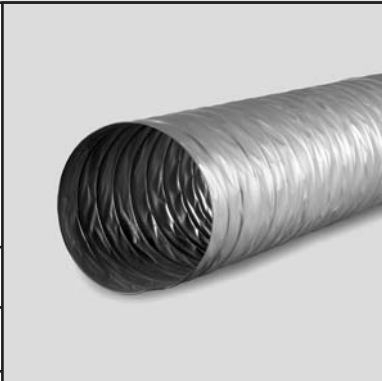

<b>B-SLP4</b>	4" x 25'	
<b>B-SLP5</b>	5" x 25'	
<b>B-SLP6</b>	6" x 25'	
<b>B-SLP7</b>	7" x 25'	
<b>B-SLP8</b>	8" x 25'	<b>B-SLP12</b> 12" x 25'
<b>B-SLP9</b>	9" x 25'	<b>B-SLP14</b> 14" x 25'
<b>B-SLP10</b>	10" x 25'	

Flexible Duct MKC - R42



<b>B-MKC4</b>	4" x 25'	
<b>B-MKC5</b>	5" x 25'	
<b>B-MKC6</b>	6" x 25'	
<b>B-MKC7</b>	7" x 25'	
<b>B-MKC8</b>	8" x 25'	<b>B-MKC12</b> 12" x 25'
<b>B-MKC9</b>	9" x 25'	<b>B-MKC14</b> 14" x 25'
<b>B-MKC10</b>	10" x 25'	<b>B-MKC16</b> 16" x 25'

### Flex Duct

#### Flexible Duct SLD



<b>B-SLD3</b>	3" x 25'	<b>B-SLD6</b>	6" x 25'
<b>B-SLD4</b>	4" x 25'	<b>B-SLD7</b>	7" x 25'
<b>B-SLD5</b>	5" x 25'	<b>B-SLD8</b>	8" x 25'

#### Flexible Duct MC - R4.2



<b>B-MCR4</b>	4" x 25'	<b>B-MCR9</b>	9" x 25'
<b>B-MCR6</b>	6" x 25'	<b>B-MCR10</b>	10" x 25'
<b>B-MCR7</b>	7" x 25'	<b>B-MCR12</b>	12" x 25'
<b>B-MCR8</b>	8" x 25'	<b>B-MCR14</b>	14" x 25'

### Aluminum Duct

#### Alumaflex Flexible Duct

<b>B-AFD3</b>	TruFlex UL Alum. 3" x 15' (450' ctn.)	<b>B-AFD4</b>	Non-Insulated 4"
<b>B-AFD4</b>	TruFlex UL Alum. 4" x 5' (270' ctn.)	<b>B-AFD5</b>	Non-Insulated 5"
<b>B-AFD5I</b>	Insulated 5"	<b>B-AFD6</b>	Non-Insulated 6"
<b>B-AFD6I</b>	Insulated 6"	<b>B-AFD7</b>	Non-Insulated 7"
<b>B-AFD3</b>	Non-Insulated 3"	<b>B-AFD8</b>	Non-Insulated 8"

## Aluminum Duct

### Deflecto Semi-Rigid Flex Duct

<b>B-DFD38</b>	3" x 8'
<b>B-DFD48</b>	4" x 8'
<b>B-DFD425</b>	4" x 25'
<b>B-DFD68</b>	6" x 8'

## Dryer Hose

### Launder-Vents

<b>B-LV3C</b>	3" Clamps
<b>B-LV4C</b>	4" Clamps
<b>B-LV320H</b>	3" x 20' Flex Hose
<b>B-LV45H</b>	4" x 5' Flex Hose
<b>B-LV48H</b>	4" x 8' Flex Hose
<b>B-LV420H</b>	4" x 20' Flex Hose

### Straps & Duct Hanging Accessories

#### Duro Dyne Nylon Dyn-O-Ties



<b>B-NDT36</b>	36" Nylon Strap (25 ctn.)
<b>B-NDT36B</b>	36" Nylon Strap (100 ctn.)
<b>B-NDT45</b>	45" Nylon Strap up to 12" Flex Duct (25 ctn.)

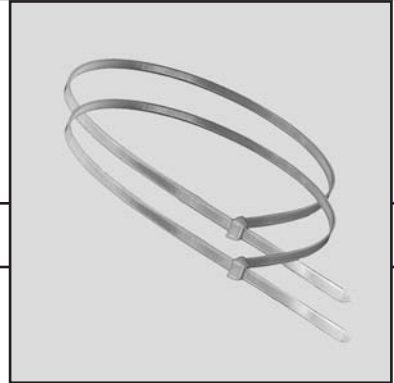

#### Duro Dyne Tools



<b>B-DDT</b>	DIT2 Installation Tool
--------------	------------------------

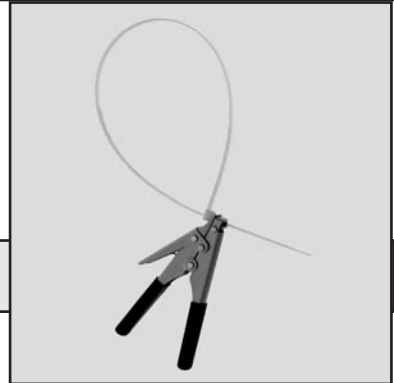

#### Duro Dyne Flex Duct Hanging Straps



<b>B-HSP</b>	3/4" x 100' Plastic
<b>B-HSE</b>	1 1/2" x 100' Excelon
<b>B-HSV</b>	1 1/2" x 200' Vinyl
<b>B-HSWE</b>	1 3/4" x 300' Woven Econo

#### Ideal Stainless Steel Worm Drive Clamps

<b>B-WDC8</b>	Max. Diameter 8 1/2"
<b>B-WDC12</b>	Max. Diameter 12"



**Straps & Duct Hanging Accessories****Panduit Tools**

<b>B-PTAT</b>	Installation Tool - Automatically Tensions & Cuts Excess
<b>B-PT</b>	Installation Tool
<b>B-PTS</b>	Panduit Strap (50 ctn.)

**Duct Wrap****Owens Corning Foil Faced**

<b>B-FDW1</b>	1 1/2" x 48" x 100'
<b>B-FDW2</b>	2" x 48" x 75'
<b>B-FDW3</b>	3" x 48" x 50'

**Schuller Microlite**

<b>B-MDW112</b>	1" x 12" x 100'
<b>B-MDW136</b>	1" x 36" x 100'
<b>B-MDW148</b>	1" x 48" x 100'
<b>B-MDW1248</b>	1 1/2" x 48" x 100'
<b>B-MDW212</b>	2" x 12" x 100'
<b>B-MDW248</b>	2" x 48" x 75'
<b>B-MDW312</b>	3" x 12" x 50'
<b>B-MDW348</b>	3" x 48" x 50'

**Vinyl Faced**

<b>B-VDW48</b>	3 1/2" x 48" x 50' Roll R11
<b>B-VDW60</b>	3 1/2" x 60" x 50' Roll R11

**Tape****Fasson Foil Tape****B-FTF2** Foil for Duct Board - 2 1/2" x 60 yrd. (SMACNA)**B-FTF3** Foil for Duct Board - 3" x 60 yrd. (SMACNA)**Nashua Duct Tape****B-DT3981** 398 - 1 1/2" x 60 yrd. (Silver)**B-DT5572** 557 - UL Listed 2" x 60 yrd. (Silver)**B-DT557S** 557 - UL Listed 3" x 60 yrd. (Silver)**Fasteners****Grip Nail Bangers****B-BSPT121** 1/2" Bangers**B-BSPT11** 1" Bangers**Duro Dyne Stick Pins****B-BSP2HW** 2 1/2" Hangers & Washers, Self Adhesive - (100 ctn.)**B-BSP34** 3/4" Self Adhesive Stick Pins & Washers - (100 ctn.)**B-BSP114** 1 1/4" Self Adhesive Stick Pins & Washers - (100 ctn.)**B-BSP134** 1 3/4" Self Adhesive Stick Pins & Washers - (100 ctn.)**B-BSP2** 2" Self Adhesive Stick Pins & Washers - (100 ctn.)**B-BSP212** 2 1/2" Self Adhesive Stick Pins & Washers - (100 ctn.)

**Fasteners**

## Duro Dyne Clip Pins



<b>B-CP12S</b>	1/2" Clip Pin w/ Stamp Cut Point - (5000 ctn.)
<b>B-CP34S</b>	3/4" Clip Pin w/ Stamp Cut Point - (5000 ctn.)
<b>B-CP112S</b>	1 1/2" Clip Pin w/ Stamp Cut Point - (3000 ctn.)

## Duro Dyne Fabric Duct Connector



<b>B-FDC4E</b>	4" x 4" x 100' Flexible Excelon roll (Black)
<b>B-FDCMFD</b>	MFD-4 Durolon
<b>B-FDCMFN</b>	MFN-4 Neoprene
<b>B-FDCMFT</b>	MFT-4 Thermafab
<b>B-FDCMF6</b>	MF6D4 Durolon
<b>B-FDCJRDD</b>	JRD-100 Durolon
<b>B-FDCJRDN</b>	JRD-100 Neoprene
<b>B-FDCEFD</b>	EFD-100 Durolon
<b>B-FDCDFDD</b>	DFD-6 Durolon - 6" x 100' roll
<b>B-FDCDFDN</b>	DFD-6 Neoprene - 6" x 100' roll
<b>B-FDCMBX</b>	MBX-4 Excelon
<b>B-FDCJBX</b>	JBX-100 Excelon
<b>B-FDCIDC</b>	IDC-343 Insulated Flex
<b>B-FDCMFN4</b>	MFN4X TDC/TDF Neoprene - 4" x 100'

**Duct Sealer & Adhesives**

Duro Dyne Insulation Adhesive



**B-IAWSA5**      WSA - 5 Gal.

**B-IAWSA53**      WSA - 53 Gal. Drum

---

Kingco Adhesive Spray

**B-NAS**      Adhesive Spray

**Hardware**

Access Door Handles



<b>B-ADH14</b>	1/4" Latch Assembly 25
<b>B-ADH38</b>	3/8" Latch Assembly 10
<b>B-ADH12</b>	1/2" Latch Assembly 10



Duro Dyne Damper Regulators & Quadrant Sets



<b>B-DRKS7</b>	KS-7 - 1/4" Jiffy Regulator Set
----------------	---------------------------------



### Hardware

#### Duro Dyne Damper Regulators & Quadrant Sets



**B-DRKS145** KS-145L - 1/4" Set Dial Regulator, Spring Lock Bearing  
(Longer Sq. End Bearing for Insulated Duct)

**B-DRKSR195** KSR - 195 - 3/8" Dial Regulator,  
Spring End Bearing, Sq End

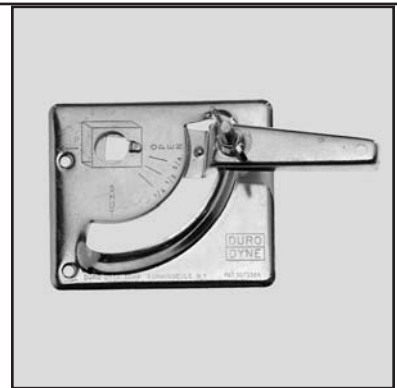

**B-DRKS3** KS-3 - 3/8" Wedge Lock Regulator Set Only

**B-DRKS385** KS-385 - 3/8" Quadrant Regulator Set - Quadrant Spring &  
Sq. End Bearings

**B-DRKS12** KS-12 - 1/2" Quadrant Set- Quadrant Rd. & Sq. End Bearings

**B-DRK4** K-4 - Quadrant for 3/8" Shaft - KS-385



**B-DRKL7R** KL-7R - 1/2" Shaft Lock for Rd. Rod

**B-DRKP6** KP-6 - 1/4" Spring Lock Bearing for use with KS-194 and others

**Hardware**

Duro Dyne Damper Regulators & Quadrant Sets

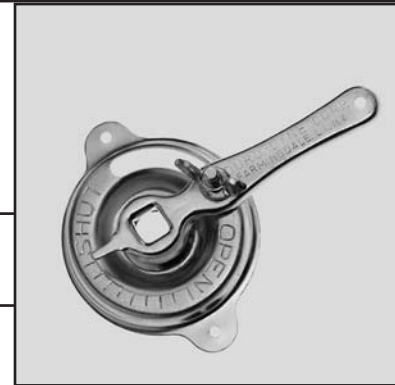

<b>B-DRKR3</b>	KR-3 - Dial Regulator for 3/8" KSR-195
<b>B-DRKP7</b>	KP-7 - 3/8" Spring Lock Bearing for use with KS-195 and others
<b>B-DRKP8S</b>	KP-8S - 1/4" Square End Bearing for use with KS-195 and others
<b>B-DRKP9R</b>	KP-9R - 3/8" Round End Bearing for use with KS-195 and others
<b>B-DRKP9S</b>	KP-9S - 3/8" Square End Bearing for use with KS-195 and others
<b>B-DRKP9L</b>	KP-9L - 3/8" Long Shaft Square End Bearing
<b>B-DRSL1</b>	SL-1 - 1/2" Sash Lock
<b>B-DRKP7L</b>	KP-7L - 3/8" Long Spring Lock Bearing

<b>B-DRSRS388</b>	SRS388 - Closed Handle	
-------------------	------------------------	---

<b>B-DRSB388</b>	SRS338 - Closed Handle Bearing	
------------------	--------------------------------	---

### Hardware

#### Duro Dyne Damper Regulators & Quadrant Sets



**B-DRSRHS388**

SRHS-388 - Open Handle



**B-DRSB138**

SB-138 - Open Handle Bearing



#### Duro Dyne Jiffy Damper Regulator Set & Parts



**B-DRSRS256**

RS-256 - Set of 2 Spring Bearings, 1 Washer, 1 Handle & 1 Wing Nut

**B-DRSRS156**

RS-156 - Set of 2 Spring Bearings, 1 Washer, 1 Handle & 1 Wing Nut

**B-DRSRB56**

RB-56 - Rapid Bearing

**B-DRSRB50**

RB-50 - Rapid Spring Bearing

**B-DRSRP1**

RP-1 - D/D Handles

**B-DRSRP2**

RP-2 - D/D Wing Nuts

**B-DRSRP3**





RP-3 - D/D Washers

**B-DRSRB2ST**

RB-2ST - Threaded Rapid Bearing



**Hardware**

Duro Dyne Damper Regulator Set & Parts		
	<p><b>B-DRSAD38</b>      AD-38 - Right Angle Drive</p>	
<p><b>B-DRCR</b></p>	<p>Concealed Regulator</p>	
<p><b>B-DRCRC</b></p>	<p>Concealed Regulator Cover</p>	

### Screws

#### Tek Screws

<b>B-BTS84</b>	8" x 3/4"
<b>B-BTS104</b>	10" x 3/4"
<b>B-BTS104B</b>	10" x 1 1/4"

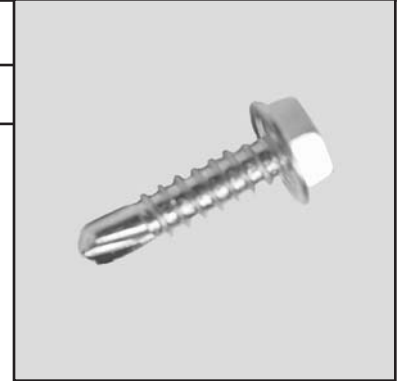

#### Zip Screws

<b>B-ZIS82</b>	8" x 1/2"
<b>B-ZIS82B</b>	8" x 1"



### Rivets

#### Duro Dyne Stainless Rivet



<b>B-SSRXX42</b>	XX42 - 1/8" Diameter .063-.125 Grip Range
<b>B-SSRXX44</b>	XX44 - 1/8" Diameter .188-.250 Grip Range

**Rivets**

Duro Dyne Rivets (Steel)



<b>B-SRSS42D</b>	SS42 - 1/8" Diameter .063-.125 Grip Range
<b>B-SRSS44D</b>	SS44 - 1/8" Diameter .188-.250 Grip Range
<b>B-SRSS64D</b>	SS64D - 3/16" Diameter .188-.250 Grip Range
<b>B-SRSS66D</b>	SS66D - 3/16" Diameter .251-.375 Grip Range



Duro Dyne Rivets (Aluminum)



<b>B-ARAA42D</b>	AA42D - 1/8" Diameter .063-.125 Grip Range
<b>B-ARAA44D</b>	AA44D - 1/8" Diameter .188-.250 Grip Range
<b>B-ARAA64D</b>	AA64D - 3/16" Diameter .188-.250 Grip Range

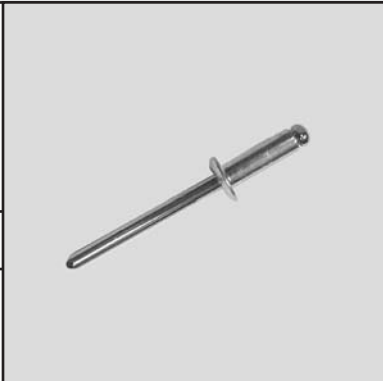

**Miscellaneous**

Screw Bits

<b>B-SB8</b>	#8
<b>B-SB10</b>	#10

# Chimney & Venting Products

Air Booster Fans.....	C2
Ventilators .....	C2 - C3
Venting Products .....	C3 - C4
Draft Diverters .....	C4
Draft Controls .....	C5

## Air Booster Fans

### Duralast Air Booster Fans - Robin Hood

<b>C-BF6</b>	6"
--------------	----

<b>C-BF8</b>	8"
--------------	----

<b>C-BF10</b>	10"
---------------	-----

<b>C-BF12</b>	12"
---------------	-----

## Ventilators

### Columbia Globe Vents

<b>C-GV4</b>	4"
--------------	----

<b>C-GV5</b>	5"
--------------	----

<b>C-GV7</b>	7"
--------------	----

<b>C-GV8</b>	8"
--------------	----

<b>C-GV9</b>	9"
--------------	----

<b>C-GV10</b>	10"
---------------	-----

<b>C-GV12</b>	12"
---------------	-----

<b>C-GV14</b>	14"
---------------	-----

<b>C-GV16</b>	16"
---------------	-----

<b>C-GV18</b>	18"
---------------	-----

## Ventilators

### Romla Rotary Ventilators

<b>C-RV6</b>	6"
<b>C-RV8</b>	8"
<b>C-RV10</b>	10"
<b>C-RV12</b>	12"
<b>C-RV14</b>	14"
<b>C-RV16</b>	16"
<b>C-RV18</b>	18"
<b>C-RV20</b>	20"
<b>C-RV24</b>	24"

## Venting Products

### Launder Vents Dryer Vent Hood

<b>C-DVH3</b>	3"
<b>C-DVH4</b>	4"

### Famco Fresh Air Intake Butterfly Dampers

<b>C-BD4</b>	4"
<b>C-BD6</b>	6"
<b>C-BD7</b>	7"
<b>C-BD8</b>	8"
<b>C-BD10</b>	10"
<b>C-BD12</b>	12"
<b>C-BD14</b>	14"
<b>C-BD16</b>	16"

## Venting Products

### Famco Fresh Air Intake Louvres

<b>C-AIL88</b>	8" x 8" to 6" Round
<b>C-AIL1210</b>	12" x 10" to 8" Round
<b>C-AIL1212</b>	12" x 12" to 10" Round

## Draft Diverters

### Excelsior Draft Diverters

<b>C-DD3</b>	3" Vertical
<b>C-DD4</b>	4" Vertical
<b>C-DD5</b>	5" Vertical
<b>C-DD6</b>	6" Vertical
<b>C-DD8</b>	8" Vertical
<b>C-DD10</b>	10" Vertical

**Draft Controls**

## Field Draft Controls

<b>C-FDC4</b>	4" Draft Control
<b>C-FDC6</b>	6" Draft Control
<b>C-FDC7</b>	7" Draft Control
<b>C-FDC8</b>	8" Draft Control
<b>C-FDC4T</b>	4" Tee Draft Control
<b>C-FDC6T</b>	6" Tee Draft Control
<b>C-FDC6M</b>	6M 6" - For 5" x 6" Pipes
<b>C-FDC6MG</b>	6MG1 6" - For 5" x 6" Pipes
<b>C-FDC6MGL</b>	6MG1 6" Less Collar
<b>C-FDC7M</b>	7M 7" - For 6" x 7" Pipes
<b>C-FDC7MG</b>	7MG1 7" - For 6" x 7" Pipes
<b>C-FDC8M</b>	8M 8" - For 7" x 8" Pipes
<b>C-FDC8MG</b>	8MG1 8" - For 7" x 8" Pipes
<b>C-FDC9M</b>	9M 9" - For 8" x 9" Pipes
<b>C-FDC9MG</b>	9MG1 9" - For 8" x 9" Pipes
<b>C-FDCMMG10</b>	M-MG2 10" - For 9" & 10" Pipes
<b>C-FDCMMG12</b>	M-MG2 12" - For 11" & 12" Pipes
<b>C-FDCMMG14</b>	M-MG2 14" - For 13" & 14" Pipes





# Products

RV Round Gas Vent	
3" RV Round.....	MB2 - MB3
4" RV Round.....	MB4 - MB5
5" RV Round.....	MB5 - MB7
6" RV Round.....	MB7 - MB8
7" RV Round.....	MB9
8" RV Round.....	MB10
QC Round Gas Vent	
10" QC Round.....	MB11
12" QC Round.....	MB11 - MB12
14" QC Round.....	MB12
WV Oval	
4" WV Oval.....	MB13
5" WV Oval.....	MB14
5"/6" WV Oval.....	MB15
Plastic Sealer.....	MB15
Venting Accessories.....	MB16 - MB18

**LOCK TAB** FEATURE FOR TYPE "B" RV GAS VENT

The LockTab™ feature was developed in response to customer feedback concerning the use of sheet metal screws to secure gas vent sections. The use of our new LockTab™ feature gives installers the option of engaging this tab instead of using sheet metal screws.

## METALBESTOS®

### TYPE "B" GAS VENT

**RV**

ROUND VENT PIPE  
3" THROUGH 8"

**QC**

ROUND VENT PIPE  
10" THROUGH 48"

**WV**

OVAL VENT PIPE  
4" THROUGH 6"

**INDIVIDUAL VENT**

**COMBINED VENT**

**COMBINED VENT**

**TYPE "B" PARTS SELECTION**

**Simply The Best**

FULLY TESTED AND LISTED  
Approved for installation in single and multi-story buildings in accordance with the standards of NFPA No. 54 and 211  
CLEARANCE TO COMBUSTIBLES  
Pipe sizes 2" through 24" require one inch clearance; pipe sizes 20" through 48" require two inch clearance.

**LIFETIME LIMITED WARRANTY**

**METALBESTOS**

**SIMPLY THE BEST**

RUGGED, SAFE CONSTRUCTION  
Double wall construction provides permanent insulation and keeps the inner pipe hot and the outer pipe relatively cool. Outer pipe is strong, durable galvanized steel and inner pipe is aluminum. Each end is die formed to assure uniform size and easy joint connection.

[www.selkirkinc.com](http://www.selkirkinc.com)

**METALBESTOS**

**SELKIRK**

**AIRMATE**

800.992.VENT (8368)

## RV Round Gas Vent

RV round vent pipe is available in pipe lengths from 6 inches to 5 feet. Its adjustable fittings and standard short lengths eliminate all cutting, fitting and special engineering. An improved short design provides for a rapid and secure connection in seconds.

### 3" RV Round Gas Vent

<b>MB-3RV6</b>	6" Pipe
<b>MB-3RV12</b>	12" Pipe
<b>MB-3RV18</b>	18" Pipe
<b>MB-3RV24</b>	24" Pipe
<b>MB-3RV36</b>	36" Pipe
<b>MB-3RV48</b>	48" Pipe
<b>MB-3RV60</b>	60" Pipe

**RV Round Gas Vent****3" RV Round Gas Vent**

<b>MB-3RV45E</b>	45° Adj. Elbow
<b>MB-3RV90E</b>	90° Adj. Elbow
<b>MB-3RV60AN</b>	60° Adj. Angle
<b>MB-3RV12A</b>	12" Adj. Length
<b>MB-3RV18A</b>	18" Adj. Length
<b>MB-3RVAVT</b>	3" Adj. Vent Termination
<b>MB-3RVI34</b>	Increaser 3" x 4"
<b>MB-3RVI35</b>	Increaser 3" x 5"
<b>MB-3RVI36</b>	Increaser 3" x 6"
<b>MB-3RVDHC</b>	Draft Hood Connector
<b>MB-3RVGPC</b>	Galv. Pipe Collar
<b>MB-3RVSC</b>	Storm Collar
<b>MB-3RVSA</b>	Support Assembly
<b>MB-3RVTP</b>	Top
<b>MB-3RVT</b>	Tee
<b>MB-3RVTC</b>	Tee Cap
<b>MB-3RVFA</b>	Female Adapter Univ. 3"
<b>MB-3RVMA</b>	Male Adapter Univ. 3"
<b>MB-3RVWS</b>	3" Wall Support Band Assembly
<b>MB-3RVWT</b>	Wall Thimble

**RV Round Gas Vent****4" RV Round Gas Vent**

<b>MB-4RV6</b>	6" Pipe
<b>MB-4RV12</b>	12" Pipe
<b>MB-4RV18</b>	18" Pipe
<b>MB-4RV24</b>	24" Pipe
<b>MB-4RV36</b>	36" Pipe
<b>MB-4RV48</b>	48" Pipe
<b>MB-4RV60</b>	60" Pipe
<b>MB-4RV45E</b>	45° Adj. Elbow
<b>MB-4RV90E</b>	90° Adj. Elbow
<b>MB-4RV60AN</b>	60° Adj. Angle
<b>MB-4RV12A</b>	12" Adj. Length
<b>MB-4RV18A</b>	18" Adj. Length
<b>MB-4RVAVT</b>	4" Adj. Vent Termination
<b>MB-4RVI45</b>	Increaser 4" x 5"
<b>MB-4RVI46</b>	Increaser 4" x 6"
<b>MB-4RVI47</b>	Increaser 4" x 7"
<b>MB-4RVI48</b>	Increaser 4" x 8"
<b>MB-4RVDHC</b>	Draft Hood Connector
<b>MB-4RVGPC</b>	Galv. Pipe Collar
<b>MB-4RVSC</b>	Storm Collar
<b>MB-4RVSA</b>	Support Assembly
<b>MB-4RVTP</b>	Top
<b>MB-4RVT</b>	Tee
<b>MB-4RVTC</b>	Tee Cap

**RV Round Gas Vent**

## 4" RV Round Gas Vent

<b>MB-4RVFA</b>	Female Adapter Univ. 4"
<b>MB-4RVMA</b>	Male Adapter Univ 4"
<b>MB-4RVWS</b>	4" Wall Support Band Assembly
<b>MB-4RVWT</b>	Wall Thimble
<b>MB-4RVAD</b>	RV to WV Adapter
<b>MB-4RVW43A</b>	Wye Fitting 4" x 4" x 3", Adjustable
<b>MB-4RVW43F</b>	Wye Fitting 4" x 4" x 3", Fixed
<b>MB-4RVW44A</b>	Wye Fitting 4" x 4" x 4", Adjustable
<b>MB-4RVW44F</b>	Wye Fitting 4" x 4" x 4", Fixed

## 5" RV Round Gas Vent

<b>MB-5RV6</b>	6" Pipe
<b>MB-5RV12</b>	12" Pipe
<b>MB-5RV18</b>	18" Pipe
<b>MB-5RV24</b>	24" Pipe
<b>MB-5RV36</b>	36" Pipe
<b>MB-5RV48</b>	48" Pipe
<b>MB-5RV60</b>	60" Pipe
<b>MB-5RV45E</b>	45° Adj. Elbow
<b>MB-5RV90E</b>	90° Adj. Elbow
<b>MB-5RV60AN</b>	60° Adj. Angle
<b>MB-5RV12A</b>	12" Adj. Length
<b>MB-5RV18A</b>	18" Adj. Length

**RV Round Gas Vent****5" RV Round Gas Vent**

<b>MB-5RVAVT</b>	5" Adj. Vent Termination
<b>MB-5RVI56</b>	Increaser 5" x 6"
<b>MB-5RVI57</b>	Increaser 5" x 7"
<b>MB-5RVI58</b>	Increaser 5" x 8"
<b>MB-5RVDHC</b>	Draft Hood Connector
<b>MB-5RVGPC</b>	Galv. Pipe Collar
<b>MB-5RVSC</b>	Storm Collar
<b>MB-5RVSA</b>	Support Assembly
<b>MB-5RVTP</b>	Top
<b>MB-5RVT</b>	Tee
<b>MB-5RVTC</b>	Tee Cap
<b>MB-5RV3RT</b>	3" Reducing Tee
<b>MB-5RV4RT</b>	4" Reducing Tee
<b>MB-5RVFA</b>	Female Adapter Univ. 5"
<b>MB-5RVMA</b>	Male Adapter Univ. 5"
<b>MB-5RVWS</b>	5" Wall Support Band Assembly
<b>MB-5RVWT</b>	Wall Thimble
<b>MB-5RVAD</b>	Adapter RV to WV

**RV Round Gas Vent****5" RV Round Gas Vent****MB-5RVW553A** Wye Fitting 5" x 5" x 3", Adjustable**MB-5RVW553F** Wye Fitting 5" x 5" x 3", Fixed**MB-5RVW543F** Wye Fitting 5" x 4" x 3", Fixed**MB-5RVW544F** Wye Fitting 5" x 4" x 4", Fixed**MB-5RVW554A** Wye Fitting 5" x 5" x 4", Adjustable**MB-5RVW554F** Wye Fitting 5" x 5" x 4", Fixed**6" RV Round Gas Vent****MB-6RV6** 6" Pipe**MB-6RV12** 12" Pipe**MB-6RV18** 18" Pipe**MB-6RV24** 24" Pipe**MB-6RV36** 36" Pipe**MB-6RV48** 48" Pipe**MB-6RV60** 60" Pipe**MB-6RV45E** 45° Adj. Elbow**MB-6RV90E** 90° Adj. Elbow**MB-6RV60AN** 60° Adj. Angle**MB-6RV12A** 12" Adj. Length**MB-6RV18A** 18" Adj. Length**MB-6RVAVT** 6" Adj. Vent Termination**MB-6RVI67** Increaser 6" x 7"**MB-6RVI68** Increaser 6" x 8"**MB-6RVDHC** Draft Hood Connector

**RV Round Gas Vent****6" RV Round Gas Vent**

<b>MB-6RVGPC</b>	Galv. Pipe Collar
<b>MB-6RVSC</b>	Storm Collar
<b>MB-6RVSA</b>	Support Assembly
<b>MB-6RVTP</b>	Top
<b>MB-6RVT</b>	Tee
<b>MB-6RVTC</b>	Tee Cap
<b>MB-6RVFA</b>	Female Adapter Univ. 6"
<b>MB-6RVMA</b>	Male Adapter Univ. 6"
<b>MB-6RVWS</b>	6" Wall Support Band Assembly
<b>MB-6RVWT</b>	Wall Thimble
<b>MB-6RVAD</b>	Adapter RV to WV
<b>MB-6RVW63A</b>	Wye Fitting 6" x 6" x 3", Adjustable
<b>MB-6RVW63F</b>	Wye Fitting 6" x 6" x 3", Fixed
<b>MB-6RVW64A</b>	Wye Fitting 6" x 6" x 4", Adjustable
<b>MB-6RVW64F</b>	Wye Fitting 6" x 6" x 4", Fixed
<b>MB-6RVW65A</b>	Wye Fitting 6" x 6" x 5", Adjustable
<b>MB-6RVW65F</b>	Wye Fitting 6" x 6" x 5", Fixed



**RV Round Gas Vent**

## 7" RV Round Gas Vent

<b>MB-7RV6</b>	6" Pipe
<b>MB-7RV12</b>	12" Pipe
<b>MB-7RV18</b>	18" Pipe
<b>MB-7RV24</b>	24" Pipe
<b>MB-7RV36</b>	36" Pipe
<b>MB-7RV48</b>	48" Pipe
<b>MB-7RV60</b>	60" Pipe
<b>MB-7RV45E</b>	45° Adj. Elbow
<b>MB-7RV90E</b>	90° Adj. Elbow
<b>MB-7RV12A</b>	12" Adj. Length
<b>MB-7RVI78</b>	Increaser 7" x 8"
<b>MB-7RVDHC</b>	Draft Hood Connector
<b>MB-7RVAVT</b>	7" Adj. Vent Termination
<b>MB-7RVGPC</b>	Galv. Pipe Collar
<b>MB-7RVSC</b>	Storm Collar
<b>MB-7RVSA</b>	Support Assembly
<b>MB-7RVTP</b>	Top
<b>MB-7RVT</b>	Tee
<b>MB-7RVTC</b>	Tee Cap
<b>MB-7RVFA</b>	Female Adapter Univ. 7"
<b>MB-7RVMA</b>	Male Adapter Univ. 7"
<b>MB-7RVWT</b>	Wall Thimble

**RV Round Gas Vent****8" RV Round Gas Vent**

<b>MB-8RV12</b>	12" Pipe
<b>MB-8RV12</b>	18" Pipe
<b>MB-8RV24</b>	24" Pipe
<b>MB-8RV36</b>	36" Pipe
<b>MB-8RV48</b>	48" Pipe
<b>MB-8RV60</b>	60" Pipe
<b>MB-8RV45E</b>	45° Adj. Elbow
<b>MB-8RV90E</b>	90° Adj. Elbow
<b>MB-8RV12A</b>	12" Adj. Length
<b>MB-8RVDHC</b>	Draft Hood Connector
<b>MB-8RVSC</b>	Storm Collar
<b>MB-8RVSA</b>	Support Assembly
<b>MB-8RVTP</b>	Top
<b>MB-8RVT</b>	Tee
<b>MB-8RVTC</b>	Tee Cap
<b>MB-8RVFA</b>	Female Adapter Univ. 8"
<b>MB-8RVMA</b>	Male Adapter Univ. 8"
<b>MB-8RVWT</b>	Wall Thimble

**QC Round Gas Vent**

QC round vent pipe is a listed type “B” gas vent pipe. Maximum weight is only 26 lbs. per foot (48" diameter). 18" and 30" lengths combined to produce required heights. Adjustable lengths eliminate cutting and fitting and provide expansion joints between fixed support points on long pipe runs.

**10" QC Round Gas Vent**

<b>MB-10QC18</b>	18" Pipe
<b>MB-10QC30</b>	30" Pipe
<b>MB-10QC45E</b>	45° Fixed Elbow
<b>MB-10QCAF</b>	Adj. Flashing
<b>MB-10QC18A</b>	18" Adj. Length
<b>MB-10QCDHC</b>	Draft Hood Connector
<b>MB-10QCSC</b>	Storm Collar
<b>MB-10QCTP</b>	Top
<b>MB-10QCT</b>	Tee
<b>MB-10QCTC</b>	Tee Cap
<b>MB-10QCSP</b>	Support Plate
<b>MB-10QCTCF</b>	Tall Cone Flat Flashing

**12" QC Round Gas Vent**

<b>MB-12QC18</b>	18" Pipe
<b>MB-12QC30</b>	30" Pipe
<b>MB-12QC45E</b>	45° Fixed Elbow
<b>MB-12QCAF</b>	Adj. Flashing
<b>MB-12QC18A</b>	18" Adj. Length
<b>MB-12QCDHC</b>	Draft Hood Connector
<b>MB-12QCSC</b>	Storm Collar

**QC Round Gas Vent****12" QC Round Gas Vent**

<b>MB-12QCTP</b>	Top
<b>MB-12QCT</b>	Tee
<b>MB-12QCTC</b>	Tee Cap
<b>MB-12QCSP</b>	Support Plate
<b>MB-12QCTCF</b>	Tall Cone Flat Flashing

**14" QC Round Gas Vent**

<b>MB-14QC18</b>	18" Pipe
<b>MB-14QC30</b>	30" Pipe
<b>MB-14QC45E</b>	45° Fixed Elbow
<b>MB-14QCAF</b>	Adj. Flashing
<b>MB-14QC18A</b>	18" Adj. Length
<b>MB-14QCSC</b>	Storm Collar
<b>MB-14QCTP</b>	Top
<b>MB-14QCT</b>	Tee
<b>MB-14QCSP</b>	Support Plate
<b>MB-14QCTCF</b>	Tall Cone Flat Flashing

**WV Oval Vent Pipe**

WV oval vent pipe, sizes 4" and 5"/6", provides for the venting capacity of 4", 5", and 6" round vent pipe. 4" WV is listed for both Type B, Type BW, and installations in a 2 x 4 wall. 5"/6" is listed as Type B gas vent and requires no special factory supplied spacing parts for installation in standard 2 x 6 walls. Adjustable fittings and standard short lengths assure fast installation.

**4" WV Oval Gas Vent**

<b>MB-4WV6</b>	6" Pipe
<b>MB-4WV12</b>	12" Pipe
<b>MB-4WV18</b>	18" Pipe
<b>MB-4WV24</b>	24" Pipe
<b>MB-4WV36</b>	36" Pipe
<b>MB-4WV48</b>	48" Pipe
<b>MB-4WV60</b>	60" Pipe
<b>MB-4WV45EF</b>	45° Elbow - Flat
<b>MB-4WV45ES</b>	45° Elbow - Standing
<b>MB-4WV12A</b>	12" Adj. Pipe
<b>MB-4WVARF</b>	Adj. Roof Flashing
<b>MB-4WVFS</b>	Firestop Spacers
<b>MB-4WVSC</b>	Storm Collar
<b>MB-4WVTP</b>	Top
<b>MB-4WVTC</b>	Tee Cap
<b>MB-4WVT4</b>	Tee w/ Fem. 4" RV Cplr.
<b>MB-4WVTS</b>	Tee w/Short Snout
<b>MB-4WVAD</b>	Adapter - WV Oval to RV

**WV Oval Vent Pipe****5" WV Oval Gas Vent**

<b>MB-5WV6</b>	6" Pipe
<b>MB-5WV12</b>	12" Pipe
<b>MB-5WV18</b>	18" Pipe
<b>MB-5WV24</b>	24" Pipe
<b>MB-5WV36</b>	36" Pipe
<b>MB-5WV48</b>	48" Pipe
<b>MB-5WV60</b>	60" Pipe
<b>MB-5WV45EF</b>	45° Elbow - Flat
<b>MB-5WV45S</b>	45° Elbow - Standing
<b>MB-5WV12A</b>	12" Adj. Pipe
<b>MB-5WVARF</b>	Adj. Roof Flashing
<b>MB-5WVFS</b>	Firestop Spacers
<b>MB-5WVSC</b>	Storm Collar
<b>MB-5WVTP</b>	Top
<b>MB-5WVTC</b>	Tee Cap
<b>MB-5WVT5</b>	Tee w/ Fem. 5" RV Cplr.
<b>MB-5WVAD</b>	Adapter - WV Oval to RV

**WV Oval Vent Pipe****5"/6" WV Oval Gas Vent**

<b>MB-56WV12</b>	12" Pipe
<b>MB-56WV18</b>	18" Pipe
<b>MB-56WV24</b>	24" Pipe
<b>MB-56WV36</b>	36" Pipe
<b>MB-56WV48</b>	48" Pipe
<b>MB-56WV60</b>	60" Pipe
<b>MB-56WV45EF</b>	45° Elbow - Flat
<b>MB-56WV45ES</b>	45° Elbow - Standing
<b>MB-56WV12A</b>	12" Adj. Pipe
<b>MB-56WVARF</b>	Adj. Roof Flashing
<b>MB-56WVFS</b>	Firestop Spacers
<b>MB-56WVSC</b>	Storm Collar
<b>MB-56WVTP</b>	Top
<b>MB-56WVTC</b>	Tee Cap
<b>MB-56WVT5</b>	Tee w/ 5" RV Cplr.
<b>MB-56WVT6</b>	Tee w/ 6" RV Cplr.
<b>MB-56WVAD</b>	Adapter - WV Oval to RV
<b>MB-56WVAD56</b>	Adapter - 5"/6" WV - 5" RV
<b>MB-56WVWTS</b>	Wall Tee Support
<b>MB-56WVBW</b>	B-W Installation Kit (33180)

**Plastic Sealer****Gas Vent Plastic Sealer**

<b>MB-GVPS</b>	1/16" Thick, 3/4" Wide, 125' Roll
----------------	-----------------------------------

**Connect  
with the Best!**



**METALBESTOS®**

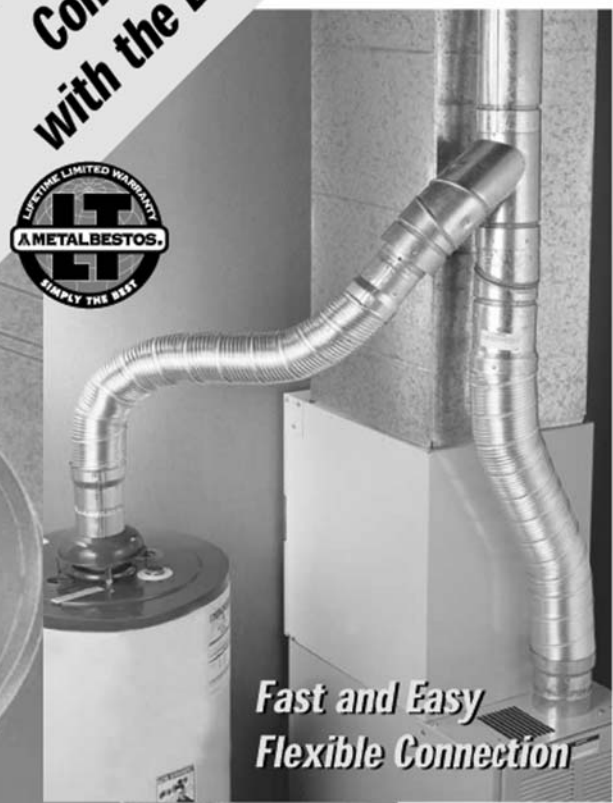

- Simple connection between appliance and Type B Vents
- *New!* UL approved as a segment of gas vent for use in attic or crawl space
- Added strength and durability due to double wall construction
- Non-positional locking system assembles with a snap to Metalbestos "B" vent
- Model DWC may be used where Type B gas vent connections are required
- No elbows required
- Reduces condensation
- Safe and economical
- 1" clearance to combustibles

*Fast and Easy  
Flexible Connection*

**DWC FLEXIBLE DOUBLE WALL  
GAS VENT SECTION**



METALBESTOS  
**SELKIRK**  
AIRMATE

800-992-VENT  
[www.selkirkinc.com](http://www.selkirkinc.com)

SDWCTENT 10/00

## Venting Accesories

### Double Wall Gas Vent

<b>MB-DW32</b>	3" x 2' Double Wall
<b>MB-DW33</b>	3" x 3' Double Wall
<b>MB-DW34</b>	3" x 4' Double Wall
<b>MB-DW35</b>	3" x 5' Double Wall



**Venting Accessories**

Double Wall Gas Vent	
<b>MB-DW3SS</b>	3" Support Spacer
<b>MB-DW32U</b>	3" x 2' Universal Double Wall
<b>MB-DW33U</b>	3" x 3' Universal Double Wall
<b>MB-DW34U</b>	3" x 4' Universal Double Wall
<b>MB-DW42</b>	4" x 2' Double Wall
<b>MB-DW43</b>	4" x 3' Double Wall
<b>MB-DW44</b>	4" x 4' Double Wall
<b>MB-DW45</b>	4" x 5' Double Wall
<b>MB-DW4SS</b>	4" Support Spacer
<b>MB-DW42U</b>	4" x 2' Universal Double Wall
<b>MB-DW43U</b>	4" x 3' Universal Double Wall
<b>MB-DW44U</b>	4" x 4' Universal Double Wall
<b>MB-DW52</b>	5" x 2' Double Wall
<b>MB-DW53</b>	5" x 3' Double Wall
<b>MB-DW54</b>	5" x 4' Double Wall
<b>MB-DW55</b>	5" x 5' Double Wall.
<b>MB-DW5SS</b>	5" Support Spacer

**Venting Accessories****SWC Gas Vent****MB-SWC32** 3" x 2'**MB-SWC33** 3" x 3'**MB-SWC34** 3" x 4'**MB-SWC35** 3" x 5'**MB-SWC42** 4" x 2'**MB-SWC43** 4" x 3'**MB-SWC44** 4" x 4'**MB-SWC45** 4" x 5'**MB-SWC52** 5" x 2'**MB-SWC53** 5" x 3'**MB-SWC54** 5" x 4'**MB-SWC55** 5" x 5'



## Registers & Grilles

### Registers

950 Series..... SH2

### Grilles

830 Series..... SH3

905 Series..... SH3

### Diffusers

825 Series..... SH4

904 Series..... SH5

MA, MA-O Series..... SH5

### Registers

950 Series Sidewall Register			
<b>SH-95088</b>	8" x 8"	<b>SH-950166</b>	16" x 6"
<b>SH-950104</b>	10" x 4"	<b>SH-950168</b>	16" x 8"
<b>SH-950106</b>	10" x 6"	<b>SH-9501610</b>	16" x 10"
<b>SH-950108</b>	10" x 8"	<b>SH-950188</b>	18" x 8"
<b>SH-9501010</b>	10" x 10"	<b>SH-950206</b>	20" x 6"
<b>SH-950124</b>	12" x 4"	<b>SH-950208</b>	20" x 8"
<b>SH-950126</b>	12" x 6"	<b>SH-9502010</b>	20" x 10"
<b>SH-950128</b>	12" x 8"	<b>SH-9502012</b>	20" x 12"
<b>SH-9501210</b>	12" x 10"	<b>SH-950246</b>	24" x 6"
<b>SH-9501212</b>	12" x 12"	<b>SH-950248</b>	24" x 8"
<b>SH-950144</b>	14" x 4"	<b>SH-9502410</b>	24" x 10"
<b>SH-950146</b>	14" x 6"	<b>SH-9502412</b>	24" x 12"
<b>SH-950148</b>	14" x 8"	<b>SH-9502414</b>	24" x 14"
<b>SH-9501410</b>	14" x 10"		
<b>SH-9501412</b>	14" x 12"		
<b>SH-9501414</b>	14" x 14"		

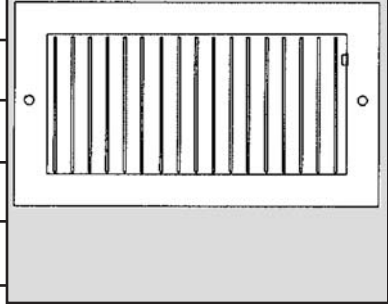

**Grilles**

830 Series Perforated T-Bar Return Air Grilles	
<b>SH-8306</b>	6"
<b>SH-8308</b>	8"
<b>SH-83010</b>	10"
<b>SH-83012</b>	12"
<b>SH-83014</b>	14"

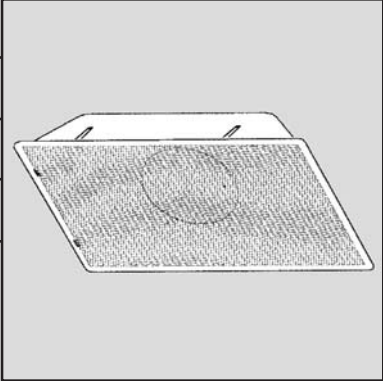

905 Series Fixed Blade Sidewall Return Air Grilles			
<b>SH-90566</b>	6" x 6"	<b>SH-9051610</b>	16" x 10"
<b>SH-90586</b>	8" x 6"	<b>SH-9051612</b>	16" x 12"
<b>SH-90588</b>	8" x 8"	<b>SH-9051616</b>	16" x 16"
<b>SH-905106</b>	10" x 6"	<b>SH-9051812</b>	18" x 12"
<b>SH-905108</b>	10" x 8"	<b>SH-9051818</b>	18" x 18"
<b>SH-9051010</b>	10" x 10"	<b>SH-905208</b>	20" x 8"
<b>SH-905126</b>	12" x 6"	<b>SH-9052010</b>	20" x 10"
<b>SH-905128</b>	12" x 8"	<b>SH-9052012</b>	20" x 12"
<b>SH-9051210</b>	12" x 10"	<b>SH-9052014</b>	20" x 14"
<b>SH-9051212</b>	12" x 12"	<b>SH-9052016</b>	20" x 16"
<b>SH-905146</b>	14" x 6"	<b>SH-9052020</b>	20" x 20"
<b>SH-905148</b>	14" x 8"	<b>SH-905246</b>	24" x 6"
<b>SH-9051410</b>	14" x 10"	<b>SH-905248</b>	24" x 8"
<b>SH-9051412</b>	14" x 12"	<b>SH-9052410</b>	24" x 10"
<b>SH-905166</b>	16" x 6"	<b>SH-9052412</b>	24" x 12"
<b>SH-905168</b>	16" x 8"	<b>SH-9052414</b>	24" x 14"



### Grilles

#### 905 Series Fixed Blade Sidewall Return Air Grilles

<b>SH-9052416</b>	24" x 16"	<b>SH-9053014</b>	30" x 14"
<b>SH-9052418</b>	24" x 18"	<b>SH-9053018</b>	30" x 18"
<b>SH-9052420</b>	24" x 20"	<b>SH-9053020</b>	30" x 20"
<b>SH-9052424</b>	24" x 24"	<b>SH-9053024</b>	30" x 24"
<b>SH-905308</b>	30" x 8"	<b>SH-9053618</b>	36" x 18"
<b>SH-9053012</b>	30" x 12"	<b>SH-9053624</b>	36" x 24"

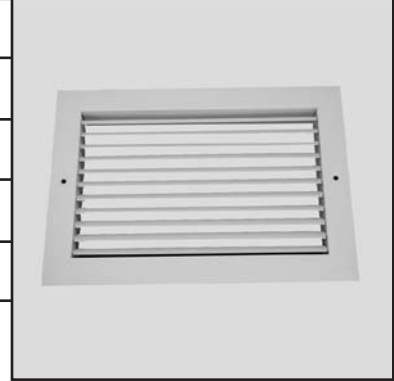

### Diffusers

#### 825 Series Perforated T-Bar Diffusers

<b>SH-8256</b>	6"
<b>SH-8258</b>	8"
<b>SH-82510</b>	10"
<b>SH-82512</b>	12"
<b>SH-82514</b>	14"

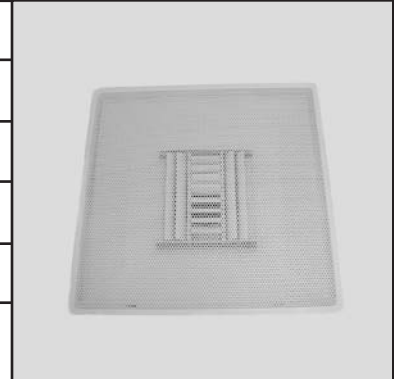

**Diffusers**

904-0 Series Double Deflection Sidewall Diffusers			
<b>SH-90488</b>	8" x 8"	<b>SH-904186</b>	18" x 6"
<b>SH-904106</b>	10" x 6"	<b>SH-904188</b>	18" x 8"
<b>SH-904108</b>	10" x 8"	<b>SH-9041810</b>	18" x 10"
<b>SH-9041010</b>	10" x 10"	<b>SH-904206</b>	20" x 6"
<b>SH-904126</b>	12" x 6"	<b>SH-904208</b>	20" x 8"
<b>SH-904128</b>	12" x 8"	<b>SH-9042010</b>	20" x 10"
<b>SH-9041210</b>	12" x 10"	<b>SH-9042012</b>	20" x 12"
<b>SH-9041212</b>	12" x 12"	<b>SH-904246</b>	24" x 6"
<b>SH-904146</b>	14" x 6"	<b>SH-904248</b>	24" x 8"
<b>SH-904148</b>	14" x 8"	<b>SH-9042410</b>	24" x 10"
<b>SH-9041410</b>	14" x 10"	<b>SH-9042412</b>	24" x 12"
<b>SH-9041414</b>	14" x 14"	<b>SH-9042414</b>	24" x 14"
<b>SH-904166</b>	16" x 6"	<b>SH-9043010</b>	30" x 10"
<b>SH-904168</b>	16" x 8"	<b>SH-9043012</b>	30" x 12"



MA, MA-O Series Modular Ceiling			
<b>SH-MA6</b>	6" x 6" - MA	<b>SH-MA06</b>	6" x 6" - MAO
<b>SH-MA8</b>	8" x 8" - MA	<b>SH-MA08</b>	8" x 8" - MAO
<b>SH-MA10</b>	10" x 10" - MA	<b>SH-MA010</b>	10" x 10" - MAO
<b>SH-MA12</b>	12" x 12" - MA	<b>SH-MA012</b>	12" x 12" - MAO
<b>SH-MA14</b>	14" x 14" - MA	<b>SH-MA014</b>	14" x 14" - MAO
<b>SH-MA16</b>	16" x 16" - MA	<b>SH-MA016</b>	16" x 16" - MAO



# Ductboard & Accessories

Take Offs.....	DB-2
Duct Board .....	DB-2
Miscellaneous .....	DB-3



### Take Offs

#### Columbia Spin In Take-Offs for Duct Board - With or Without Damper

<b>DB-STOD5</b>	5"	
<b>DB-STOD6</b>	6"	
<b>DB-STOD7</b>	7"	
<b>DB-STOD8</b>	8"	
<b>DB-STOD9</b>	9"	
<b>DB-STOD10</b>	10"	
<b>DB-STOD12</b>	12"	
<b>DB-STOD14</b>	14"	
<b>DB-STOD16</b>	16"	
<b>DB-STOD18</b>	18"	

<b>DB-STODB6</b>	6" - Bell Spin In w/ Damper
<b>DB-STODB8</b>	8" - Bell Spin In w/ Damper
<b>DB-STODB10</b>	10" - Bell Spin In w/ Damper
<b>DB-STODB12</b>	12" - Bell Spin In w/ Damper

### Duct Board

#### Fittings - Call for quotes

ROLOK PRODUCTS

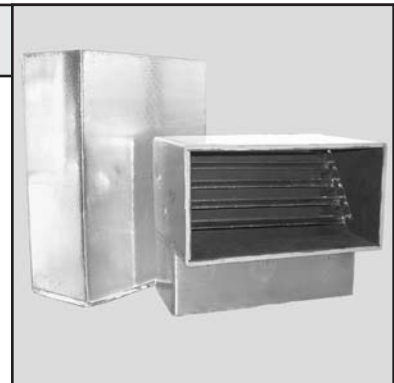

**Miscellaneous**

Duro Dyne Quieturn Vanes



**DB-DQV** Per Ft.

Rigid Round Fiberglass Duct Foil Jacketed J/M Fisk

<b>DB-RRF6</b>	6" x 6'
<b>DB-RRF7</b>	7" x 6'
<b>DB-RRF8</b>	8" x 6'
<b>DB-RRF9</b>	9" x 6'
<b>DB-RRF10</b>	10" x 6'
<b>DB-RRF12</b>	12" x 6'
<b>DB-RRF14</b>	14" x 6'
<b>DB-RRF16</b>	16" x 6'
<b>DB-RRF18</b>	18" x 6'

# Miscellaneous Consumables & Supplies

Adhesives.....	MC2
Caulking Guns .....	MC2
Dust Mask .....	MC3
Gasket Sealant.....	MC3
Sealants .....	MC3 - MC6
Brushes & Accessories .....	MC6
Miscellaneous Supplies .....	MC7

### Adhesives

#### 3M Insulation Adhesive

**MC-IA**                      Aerosol Spray Insulation Adhesive

### Sealants

#### Caulking Guns

**ABC-UCG**                      Utility Caulking Gun (11 oz. Tube Capacity)



**ABC-CG**                      Caulking Gun (1/10 gal. Tube capacity)



## Dust Mask

### 3M Dust Mask

**MC-DM** 3M Dust Mask (50 ctn.)

## Gasket Sealant

### Foam Tape Sealant

**ABC-FTS**

Closed cell neoprene sponge P/S one side (adhesive)  
Black in color  $\frac{1}{16}$ " through  $\frac{3}{4}$ " thick - widths to 42" wide  
25 and 50ft long rolls  
Excellent gasketing material - SC - 41  
Meets UL 94 Classification

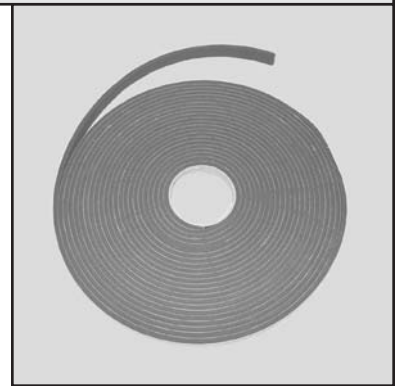

## Sealants

### Alcoa Gutterseal

**MC-G** Alum Colored 5 oz.

### Boss #350 Siliconized Acrylic-Latex

**ABC-B350T** 11 oz & 30 oz sizes

Boss 350 HVAC Flame retardant sealant that meets U.L. Specification #723.

Flame Spread... 0 Smoke Developed ... 0  
Excellent for sealing round, oval, and square duct work. Cures to a tough flexible film that resists sharp blows and impacts when cured. High or low pressure systems - mild odor.



### Sealants

#### Boss #350 Siliconized Acrylic-Latex

**ABC-B350B** 1 Gal., 2 Gal., & 5 Gal. sizes

Boss 350 HVAC Flame retardant sealant that meets U.L. Specification #723.

Flame Spread... 0 Smoke Developed ... 0  
Excellent for sealing round, oval, and square duct work. Cures to a tough flexible film that resists sharp blows and impacts when cured. High or low pressure systems - mild odor.



#### Boss #380 Contractor's 100 % RTV Silicone

**ABC-B380T** 11 oz cartridge & 5 Gal. bucket sizes

Boss #380 is excellent for kitchens. FDA approved application. USDA approved. Sheet metal -60° to 400° F.

#370 HVAC R. Silicone - -85° to 500° F.  
#326 Hi Temp Red Color - -85° to 600° F.



#### Dow Corning 999-A Building & Glazing Silicone

**ABC-DC999T** 11 oz Tube

Conventional glazing glass sealant and building sealant.

1 part sealant.

Avoid painting over unless testing for adhesion.

Has been used for years on the market.



**Sealants**

**Metacaulk MC 150+ Firestopping**

**ABC-MC150T** 11 oz & 30 oz cart., 2 gal. & 5 gal. buckets

MC 150 - 1 hr & 2 hr rating. Smooth texture, red in color. Paintable.

Metacaulk 1000 - 3 to 4 hr rating. Excellent high quality product.  
Metacaulk 835+ silicone - Gray in color, inside/outside.  
Also - Collars, Putty Pads, Pillows, Fire Rated mortar & Wrap Strip



**Sikaflex 1a Constuction**

**ABC-S1ACT** 11 oz Cartridge

One componant polyurethane sealant.

High performance premium grade, elastometric joint sealant.

This product is sold world wide.



**Vulkem 921 Polyurethane**

**ABC-V921T** 10.2 oz cart., 2 gal. & 5 gal. buckets

One part polyurethane sealant - Low modulus.

Exterior & Interior use.



**Brushes & Accessories**

## Miscellaneous Brushes &amp; Accessories

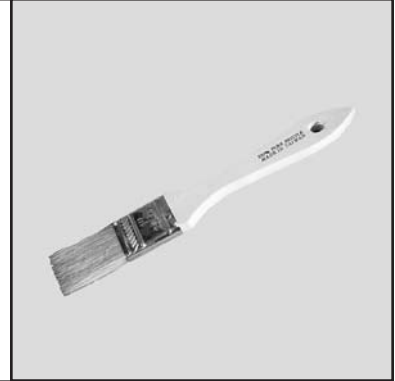
**ABC-2WH** 2" Wood Handle**MC-BAPB1** 1 1/2" Economy Paint Brush**MC-BAPB2** 2" Economy Paint Brush**MC-BAPB3** 3" Economy Paint Brush**MC-BAPHSB** Plastic Handle Stainless Brush (3 pk.)**MC-BAWHSB** Wood Handle Stainless Brush (3 pk.)**MC-BAWHB3** 3" Wood handle Bristle Brush**MC-BAAB** Acid Brushes**MC-BAWMB** Weil McClain Brush - Fine Wire 1 1/2" diameter**MC-BACB** Columbia Brush - Fine wire .006" Brush, 1" x 1/2" use with Columbia Boilers**MC-BADB2** 2" Disposable Brush - Wood Handled**MC-BAGR** Gasket Remover



**Miscellaneous Supplies**

Rectorseek Leak Locator

**ABC-RLL** Spray Bottle



Hardcast Sealant Tape

**MC-ST2FG** 2" x 100' Foil-Grip

**MC-ST3FG** 3" x 100' Foil-Grip.

**MC-ST2AG** 2" x 50' Aluma-grip

**MC-ST3AG** 3" x 50' Aluma-grip

**Spray Paint**

DAP Spray Paints

**MC-SPFG** Flat Gray Primer 12 oz.

**MC-SPFW** Flat White Enamel w/ Built in Primer 12 oz.

**MC-SPGR** Gloss Red Enamel w/ Built in Primer 12 oz.

**MC-SPGW** Gloss White Enamel (OSHA) w/ Built in Primer 12 oz.

**MC-SPA E** Aluminum Enamel w/ built in Primer 12 oz.

**MC-SPFK** Flat Black Enamel w/ Built inn Primer 12 oz.

**MC-SPGB** Gloss Brown Enamel w/ Built in Primer 12 oz.

**MC-SPBK** BBQ & Stove Black 13 oz.

**MC-SPGY** Gloss Golden Yellow Enamel w/ Built in Primer 12 oz.

**MC-SPHW** Hi-Temp White Enamel 12 oz.

# Technical Data

Duct Construction Standards	
2" .....	TD2
4" .....	TD3
6" .....	TD4
Diameters, Weight, Gauge and Strength Properties of Spiral Duct.....	TD5
Hydrostatic Pressure Tests on Spiral Tubing.....	TD6
Allowable Negative Pressures of Round Spiral Duct.....	TD7
Performance Comparison Test	
45° Lateral.....	TD8
45° Lateral with 45° Elbow.....	TD9
Conical Tees.....	TD10
Round Duct Gauge Selection.....	TD11

### Duct Construction Standards

**W.G.: 2"**

**Material: Galvanized**

Sealer: Joint Connections

Seams: 24-26 ga.: Snaplock  
18-22 ga.: Pittsburgh

<b>D</b>	Drive (24 ga.)	<b>TDC</b>	Transverse Duct Connector
<b>SD</b>	Standing Drive (22 ga.)	<b>IRA</b>	Intermediate Reinforcing Angle
<b>S</b>	S-lock (24 ga.)	<b>MPT</b>	Midpoint Tie Rod
<b>SS</b>	Standing S-lock	<b>JTR</b>	Joint Tie Rod

Duct Size	Gauge	Connection Joint			Reinforcement
		Centers	Major	Minor	
10" & dn	24	59"	S	D	None
11" - 14"	24	59"	SS	SD	None
15" - 20"	24	59"	SS	SD	None
21" - 30"	24	56"	TDC	TDC	None
31" - 36"	22	56"	TDC	TDC	None
37" - 42"	24	56"	TDC	TDC	MPT
43" - 54"	22	56"	TDC	TDC	MPT
55" - 84"	22	56"	TDC	TDC	JTR (2) MPT
85" - 96"	20	56"	TDC	TDC	JTR (2) MPT
97" - 120"	18	56"	TDC	TDC	JTR/MPT/IRA (2 1/2 x 1/8)

- (1) Based upon 1995 SMACNA HVAC Duct Construction Standards.
- (2) Install tie rods (JTR & MPT) at 60" spacing for ducts over 120" wide.
- (3) All duct beaded or crossbroken.
- (4) Fittings and duct reinforced alike.
- (5) JTR's required on both sides of joint.
- (6) Refer to job specifications for specific sealer requirements.



**Duct Construction Standards**

**W.G.: 4"**

**Material: Galvanized**

Sealer: All joints & seams

Seams: Pittsburgh

<b>D</b>	Drive (24 ga.)	<b>TDC</b>	Transverse Duct Connector
<b>SD</b>	Standing Drive (22 ga.)	<b>IRA</b>	Intermediate Reinforcing Angle
<b>S</b>	S-lock (24 ga.)	<b>MPT</b>	Midpoint Tie Rod
<b>SS</b>	Standing S-lock	<b>JTR</b>	Joint Tie Rod

Duct Size	Gauge	Connection Joint			Reinforcement
		Centers	Major	Minor	
16" & dn	24	59"	S	D	None
17" - 22"	24	56"	TDC	TDC	None
23" - 28"	22	56"	TDC	TDC	None
29" - 30"	20	56"	TDC	TDC	None
31" - 36"	20	56"	TDC	TDC	JTR
37" - 60"	22	56"	TDC	TDC	JTR (2) MPT
61" - 72"	20	56"	TDC	TDC	JTR (2) MPT
73" - 96"	18	56"	TDC	TDC	JTR (2) MPT
97" - 120"	18	56"	TDC	TDC	JTR/MPT/IRA (2 1/2 x 3/16)

- (1) Based upon 1995 SMACNA HVAC Duct Construction Standards.
- (2) Install tie rods (JTR & MPT) at 60" spacing for ducts over 120" wide.
- (3) All duct beaded or crossbroken.
- (4) Fittings and duct reinforced alike.
- (5) JTR's required on both sides of joint.
- (6) Refer to job specifications for specific sealer requirements.



### Duct Construction Standards

**W.G.: 6"**

**Material: Galvanized**

Sealer: All joints & seams

Seams: Pittsburgh

<b>D</b>	Drive (24 ga.)	<b>TDC</b>	Transverse Duct Connector
<b>SD</b>	Standing Drive (22 ga.)	<b>IRA</b>	Intermediate Reinforcing Angle
<b>S</b>	S-lock (24 ga.)	<b>MPT</b>	Midpoint Tie Rod
<b>SS</b>	Standing S-lock	<b>JTR</b>	Joint Tie Rod

Duct Size	Gauge	Connection Joint			Reinforcement
		Centers	Major	Minor	
12" & dn	24	59"	TDC	TDC	None
13" - 24"	22	56"	TDC	TDC	None
25" - 26"	20	56"	TDC	TDC	None
27" - 28"	20	56"	TDC	TDC	JTR
29" - 30"	22	56"	TDC	TDC	IRA (1 1/2 x 1/8)
31" - 36"	20	56"	TDC	TDC	IRA (1 1/2 x 1/8)
37" - 48"	20	56"	TDC	TDC	IRA (1 1/2 x 1/8)
49" - 54"	20	56"	TDC	TDC	IRA (1 1/2 x 1/8)
55" - 72"	18	56"	TDC	TDC	IRA (1 1/2 x 1/8)
73" - 96"	18	56"	TDC	TDC	JTR/MPT (Note 7)
97" - 120"	18	56"	TDC	TDC	JTR/MPT/IRA (2 1/2 x 3/16) Note 7

- (1) Based upon 1995 SMACNA HVAC Duct Construction Standards.
- (2) Install tie rods (JTR & MPT) at 60" spacing for ducts over 120" wide.
- (3) All duct beaded or crossbroken.
- (4) Fittings and duct reinforced alike.
- (5) JTR's required on both sides of joint.
- (6) Refer to job specifications for specific sealer requirements.



<b>Diameters, Weight, Gauge and Strength                      Properties of Spiral Duct</b> All ROLOK duct meets ASTM A924, G90 coating				
Diameter (inches)	Weight lb/ft	Gauge Std.	Internal Negative Pressure to Collapses	
			wg	psi
3	.083	26	*	
4	1.08	26	*	
5	1.35	26	*	
6	1.54	26	238.0	8.59
7	1.79	26	155.0	5.60
8	2.06	26	72.0	2.60
9	2.94	24	174.0	6.28
10	3.26	24	137.0	4.96
11	3.58	24	88.0	3.20
12	3.84	24	62.5	2.26
14	4.46	24	34.0	1.23
16	5.10	24	32.0	1.15
18	5.73	24	30.0	1.10
20	6.37	24	29.0	1.05
22	7.00	24	28.0	1.01
24	9.45	22	30.0	1.10
26	10.24	22	30.0	1.10
28	11.07	22	29.0	1.08
30	11.86	22	29.0	1.06
32	12.65	22	29.0	1.05
34	13.45	22	28.0	1.03
36	14.22	22	27.0	1.00

\* did not fail at 10 p.s.i.

### Hydrostatic Pressure Tests

Hydrostatic Pressures to Seam Failure on Spiral Tubing.  
Tests conducted by the Testing Institute of Oslo, Oslo, Norway.

Dia. Inches	26 ga		24 ga		22 ga		20 ga		18 ga	
	psi	wg	psi	wg	psi	wg	psi	wg	psi	wg
3	420	11634.0	650	14819.5	650	18005.0	765	21190.5	995	27561.5
4	308	8531.6	392	10858.4	475	13157.5	560	15512.0	728	20165.6
5	238	6592.6	303	8393.1	369	10221.3	435	12049.5	566	15678.2
6	199	5512.3	252	6980.4	308	8531.6	363	10055.1	473	13102.1
7	169	4681.3	216	5983.2	262	7257.4	309	8559.3	403	11163.1
8	145	4016.5	186	5152.2	224	6204.8	264	7312.8	344	9528.8
9	127	3517.9	161	4459.7	196	5429.2	230	6371.0	299	8282.3
10	113	3130.1	144	3988.8	177	4902.9	208	5761.6	271	7506.7
12	93	2576.1	118	3268.6	145	4016.5	171	4736.7	223	6177.1
14	76	2105.2	100	2770.0	120	3324.0	142	3933.4	185	5124.5
16	68	1883.6	86	2382.2	103	2853.1	122	3379.4	162	4487.4
18			75	2077.5	91	2520.7	104	2880.8	136	3767.2
20			66	1828.2	81	2243.7	96	2659.2	125	3462.5
22			60	1662.0	72	1994.4	85	2354.5	111	3074.7
24					66	1828.2	78	2160.6	101	2797.7
26					61	1689.7	72	1994.4	94	2603.8
28					55	1523.5	65	1800.5	85	2354.5
30					51	1412.7	60	1662.0	78	2160.6
32					47	1301.9	56	1551.2	73	2022.1
34							52	1440.4	68	1883.6
36							48	1329.6	65	1800.5
38							45	1246.5	59	1634.3
40							42	1163.4	55	1523.5
42							39	1080.3	51	1412.7
44									47	1301.9
46									44	1218.8
48									41	1135.7
50									39	1080.3

**Allowable Negative Pressures in Round Spiral Duct**

The following table lists the recommended metal gauge and reinforcing for various negative pressures in different diameters of round spiral duct. The negative pressures listed are working pressures with a safety factor of 3 included

**MAXIMUM NEGATIVE PRESSURES**

Diameter	0" - 10" wg	10" - 20" wg	20" - 30" wg	30" x 40" wg
3-7	26 ga	26 ga	26 ga	26 ga
8	26 ga	26 ga	26 ga	24 ga
9-12	24 ga	24 ga	22 ga	22 ga
13-15	24 ga	22 ga	22 ga	20 ga
16-18	22 ga	20 ga	20 ga	18 ga
19-22	22 ga	18 ga	18 ga	w/fl 18 ga or 16 ga
24-26	20 ga	18 ga	w/fl 18 ga or 16 ga	w/fl 18 ga 6' c-c or 16 ga 12' c-c
28-34	18 ga	w/ fl 18 ga or 16 ga	w/fl 18 ga 6' c-c or 16 ga 12' c-c	w/fl 18 ga 4' c-c or 16 ga 12' c-c
36-42	w/ fl 18 ga or 16 ga	w/fl 18 ga 6' c-c or 16 ga 12' c-c	w/fl 18 ga 4' c-c or 16 ga 12' c-c	w/fl 16 ga
44-50	w/fl 18 ga	w/fl 18 ga 6' c-c or 16 ga 12' c-c	w/fl 16 ga 12' c-c	w/fl 16 ga 6' c-c
52-60	w/fl 18 ga 6' c-c or 16 ga 12' c-c	w/fl 18 ga 4' c-c or 16 ga 12' c-c	w/fl 16 ga 6' c-c	w/fl 16 ga 6' c-c



## Performance Comparison Test

### 45° Lateral

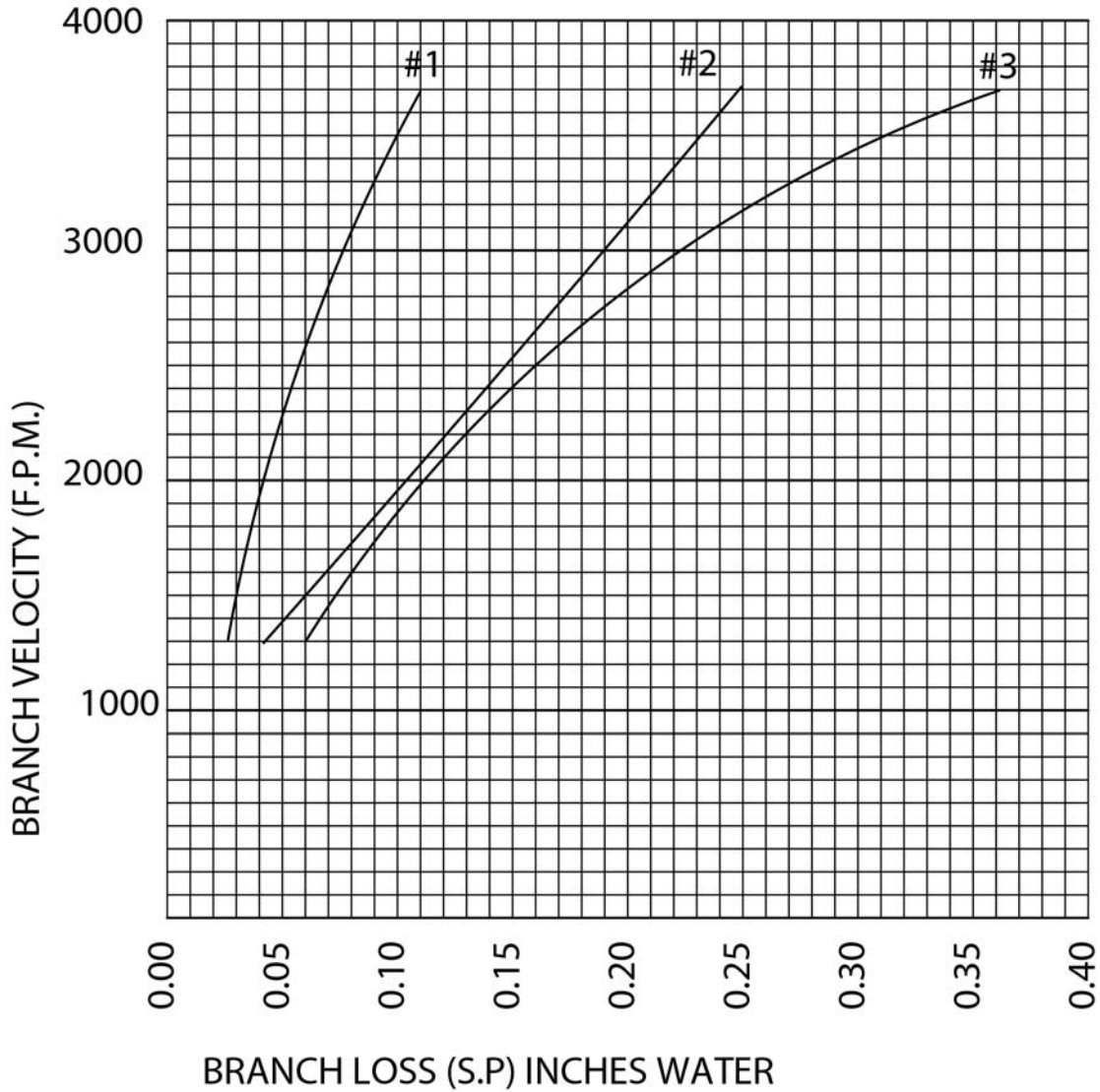

#1



#2



#3

**Performance Comparison Test**

**45° Lateral with 45° Elbow**

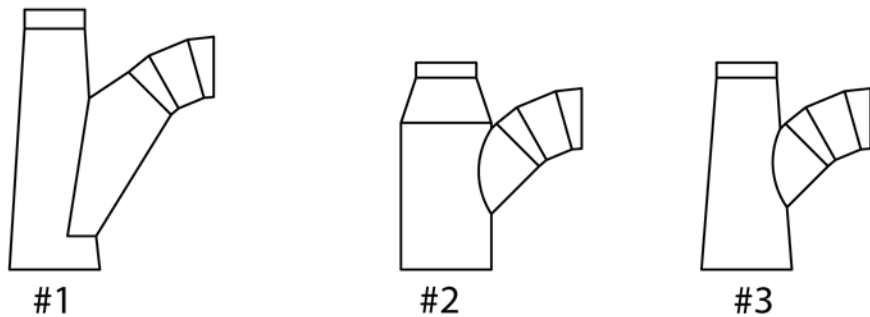
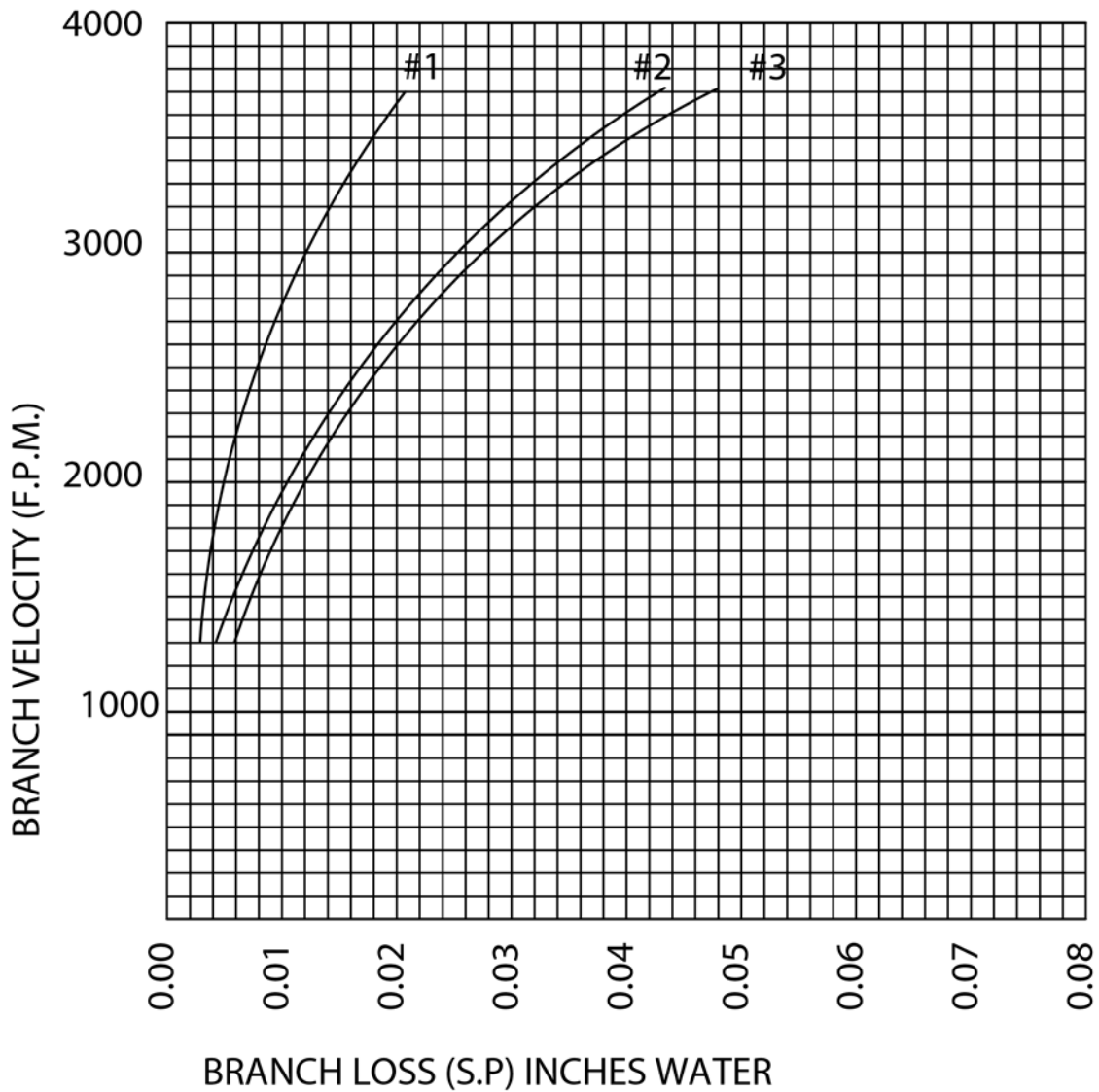

### Performance Comparison Test

#### Conical Tees

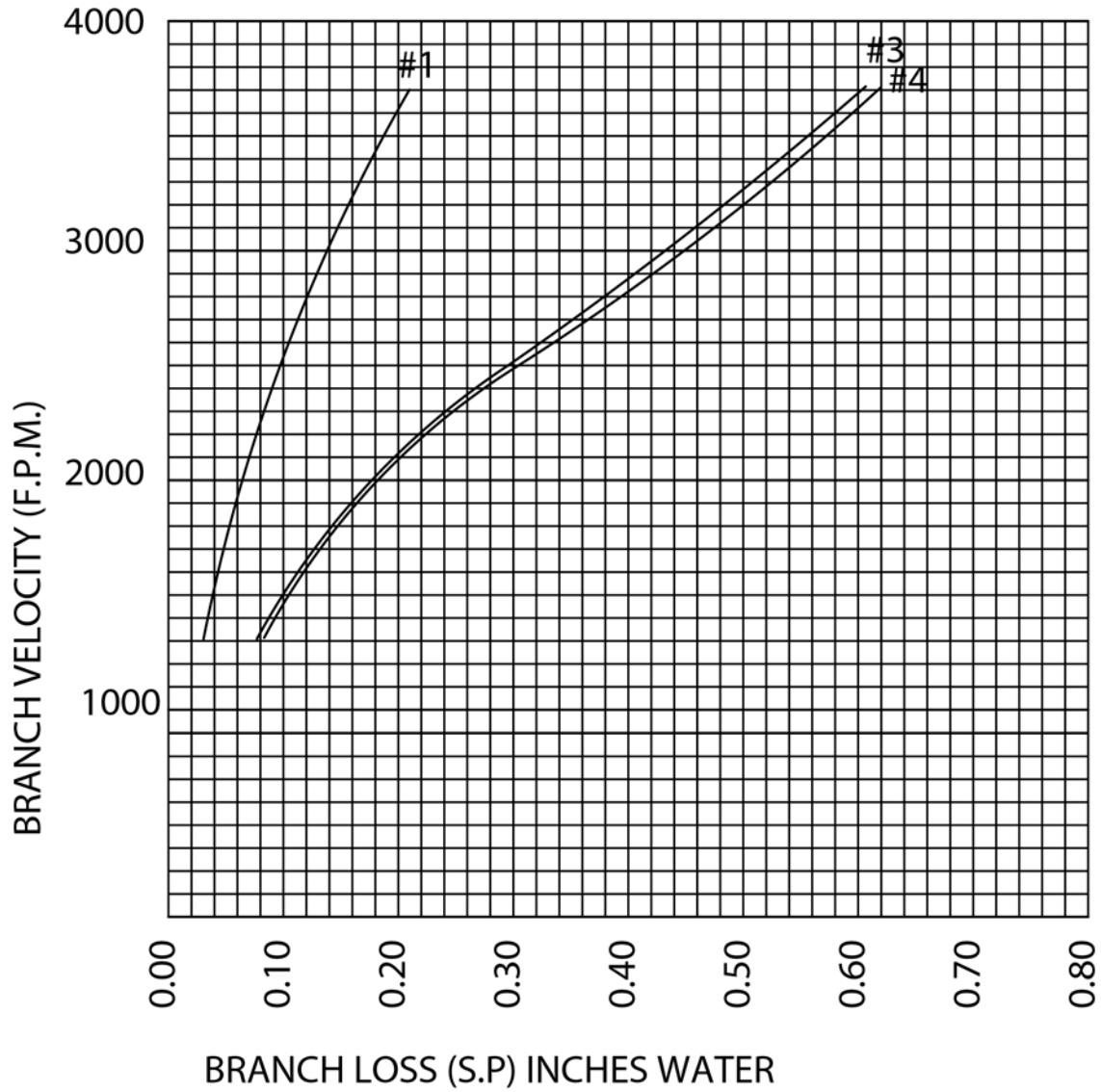

BRANCH LOSS (S.P) INCHES WATER



#1



#3



#4

<b>Round Duct Gauge Selection</b> Galvanized Steel / Positive Pressure			
Duct Diameter in inches	Gauge		
	2" wg	4" wg	10" wg
6	28	28	28
8	28	28	28
10	28	28	28
12	28	28	26
14	26	26	26
16	26	26	24
18	24	24	24
19 - 26	24	24	24
27 - 36	24	22	22
37 - 50	22	20	20
51 - 60	20	18	18

**NOTE: 10 ft max. length for 28 ga. spiral**

